

DESIGN PLUS

SILANTRA COLLECTION
AWARDED WITH DESIGN PLUS
PRIZE(L+B, FRANKFURT)2006.



DESIGN PLUS

SILANTRA COLLECTION
AWARDED WITH DESIGN PLUS
PRIZE(L+B, FRANKFURT)2006.

SILANTRA

Christophe Mathieu, para Bover. 2005

Cuando observo las fachadas de algunos edificios, hay elementos y formas que me sugieren otros objetos que probablemente no tengan nada que ver con lo observado.

Así nació Silantra: trasladando con la imaginación ciertas características de la arquitectura moderna y contemporánea como ciertas rejillas de ventilación, las persianas de librillo utilizadas por Coderch o la fachada del Edificio IRCAM, París, de Renzo Piano.

De este modo intentaba imaginarme las Silantras:
 ... Grandes pantallas de luminosidad, elegancia en los materiales.

... Luz cálida y con marcado carácter arquitectónico.

... La horizontal como elemento formal destacado.

... Y la abstracción, racionalismo y funcionalidad como características comunes al movimiento moderno.

Las pletinas de aluminio anodizado y pulido de 50X5 mm. de espesor hacen de marco y parte estructural de las delicadas cintas de aspecto sedoso. Las pletinas se encuentran sólo en dos de los cuatro lados de la pantalla coincidiendo y reforzando la horizontalidad de las cintas y dando, asimismo, sentido de movimiento y continuidad a las pantallas, como en los paneles correderos de madera del Edificio Balmes de Carlos Ferrater.

Las pantallas, apenas separadas unos pocos centímetros de la pared, permiten que la luz salga en todo su perímetro infiriendo ligereza a la lámpara y una mayor luminosidad.







DESIGN PLUS

**SILANTRA COLLECTION
AWARDED WITH DESIGN PLUS
PRIZE(L+B, FRANKFURT)2006.**

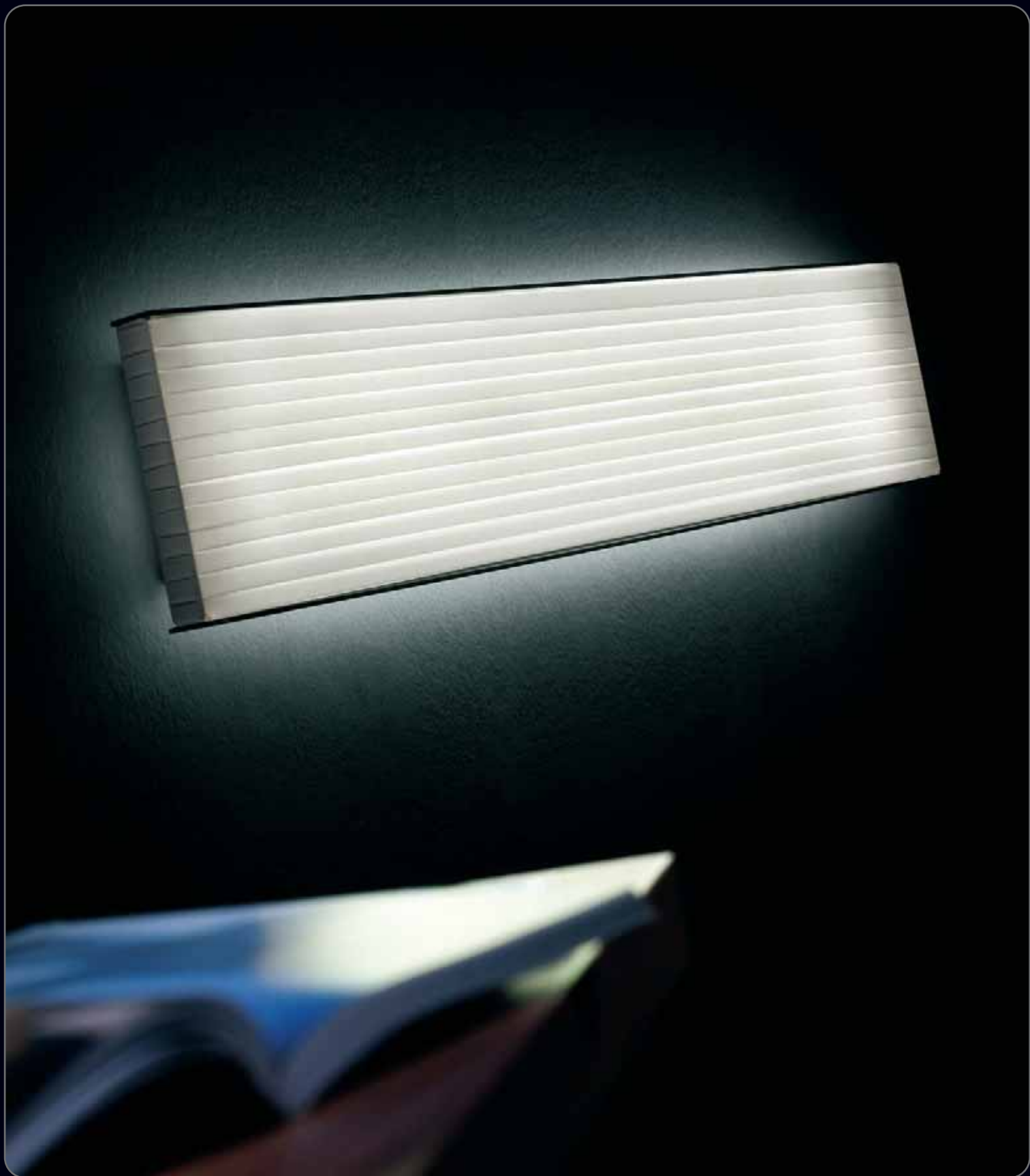

DESIGN PLUS

SILANTRA COLLECTION
AWARDED WITH DESIGN PLUS
PRIZE(L+B, FRANKFURT)2006.



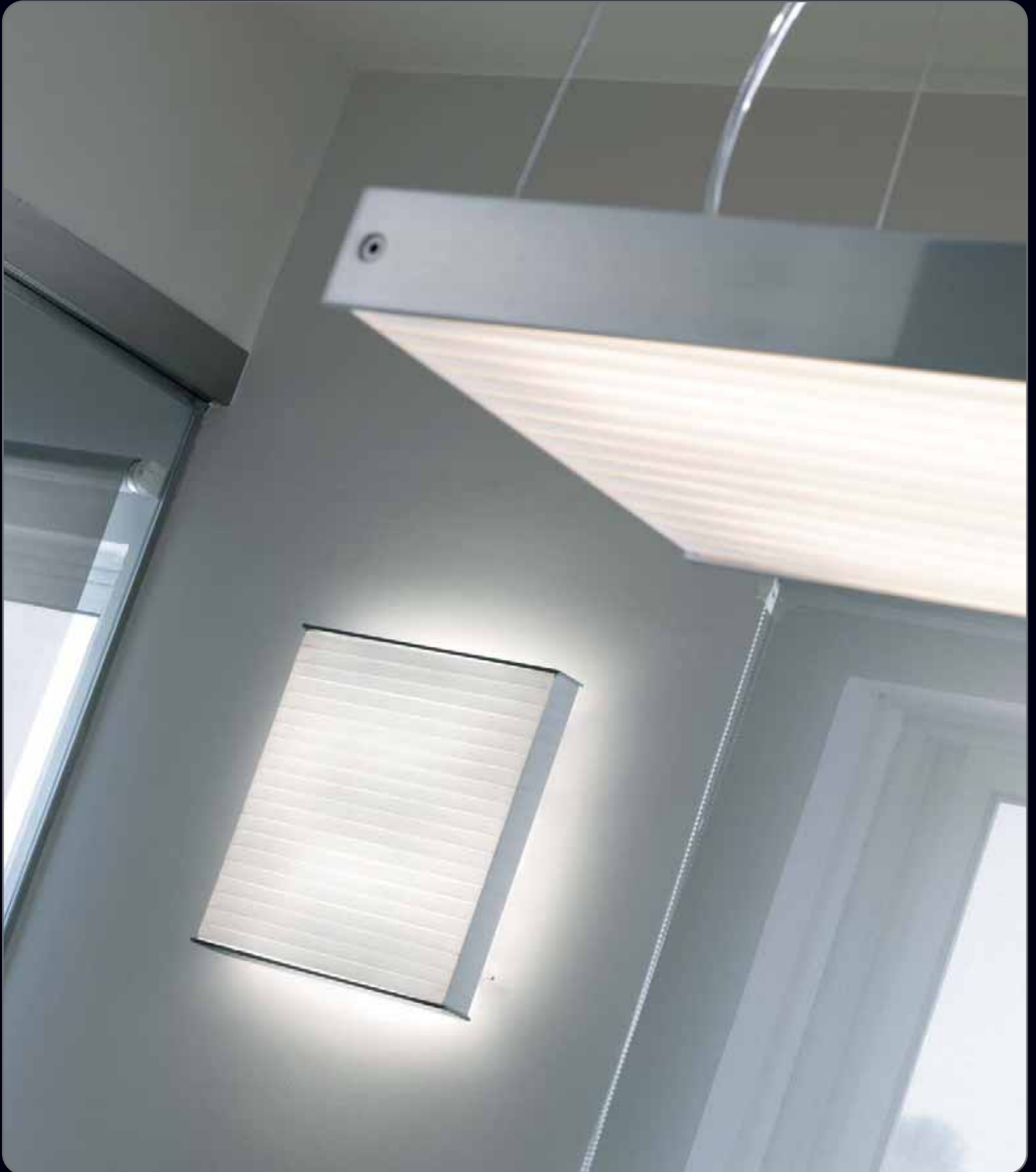



DESIGN PLUS

SILANTRA COLLECTION
AWARDED WITH DESIGN PLUS
PRIZE(L+B, FRANKFURT)2006.





SILANTRA 01

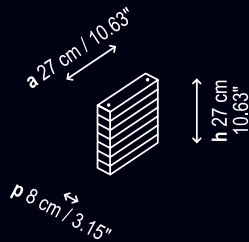

SILANTRA 02

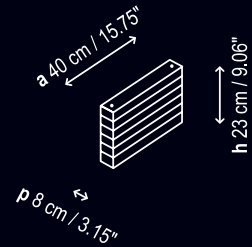

SILANTRA 03 F SILANTRA 03 H

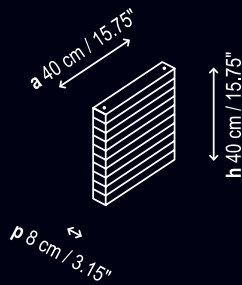

SILANTRA 04

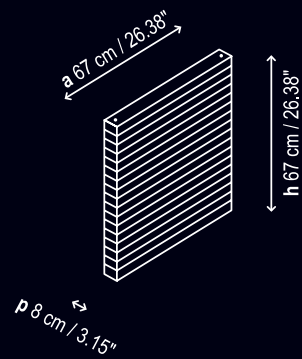

SILANTRA 01
APLIQUE-PLAFÓN / WALL LIGHT-CEILING

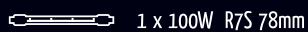

SILANTRA 02
APLIQUE-PLAFÓN / WALL LIGHT-CEILING

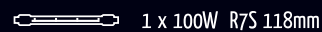

SILANTRA 03
APLIQUE-PLAFÓN / WALL LIGHT-CEILING

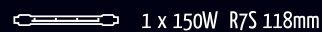

SILANTRA 04
APLIQUE-PLAFÓN / WALL LIGHT-CEILING



SILANTRA 05

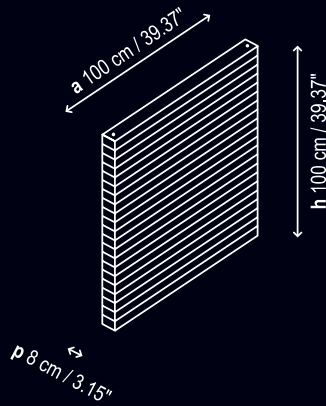

SILANTRA 06

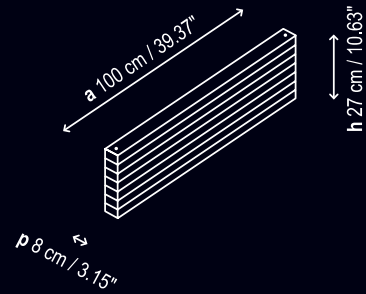

SILANTRA 07

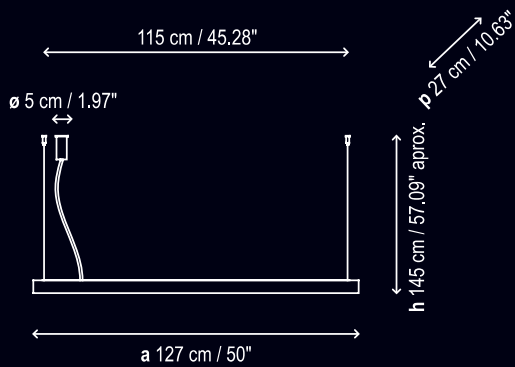

SILANTRA 05

APLIQUE-PLAFÓN / WALL LIGHT-CEILING



230V 50Hz

4 x 39W T5 Fluorescente
 Reactancia electrónica
 Electrical ballast

SILANTRA 06

APLIQUE-PLAFÓN / WALL LIGHT-CEILING

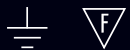

230V 50Hz

2 x 39W T5 Fluorescente
 Reactancia electrónica
 Electrical ballast

SILANTRA 07

LÁMPARA SUSPENSIÓN / PENDANT LAMP

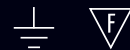

230V 50Hz

2 x 54W T5 Fluorescente
 Reactancia electrónica
 Electrical ballast