

T E C H N I C A L L I G H T I N G

T E C H N I C A L L I G H T I N G



PROMETEOLIGHT

PROMETEOLIGHT

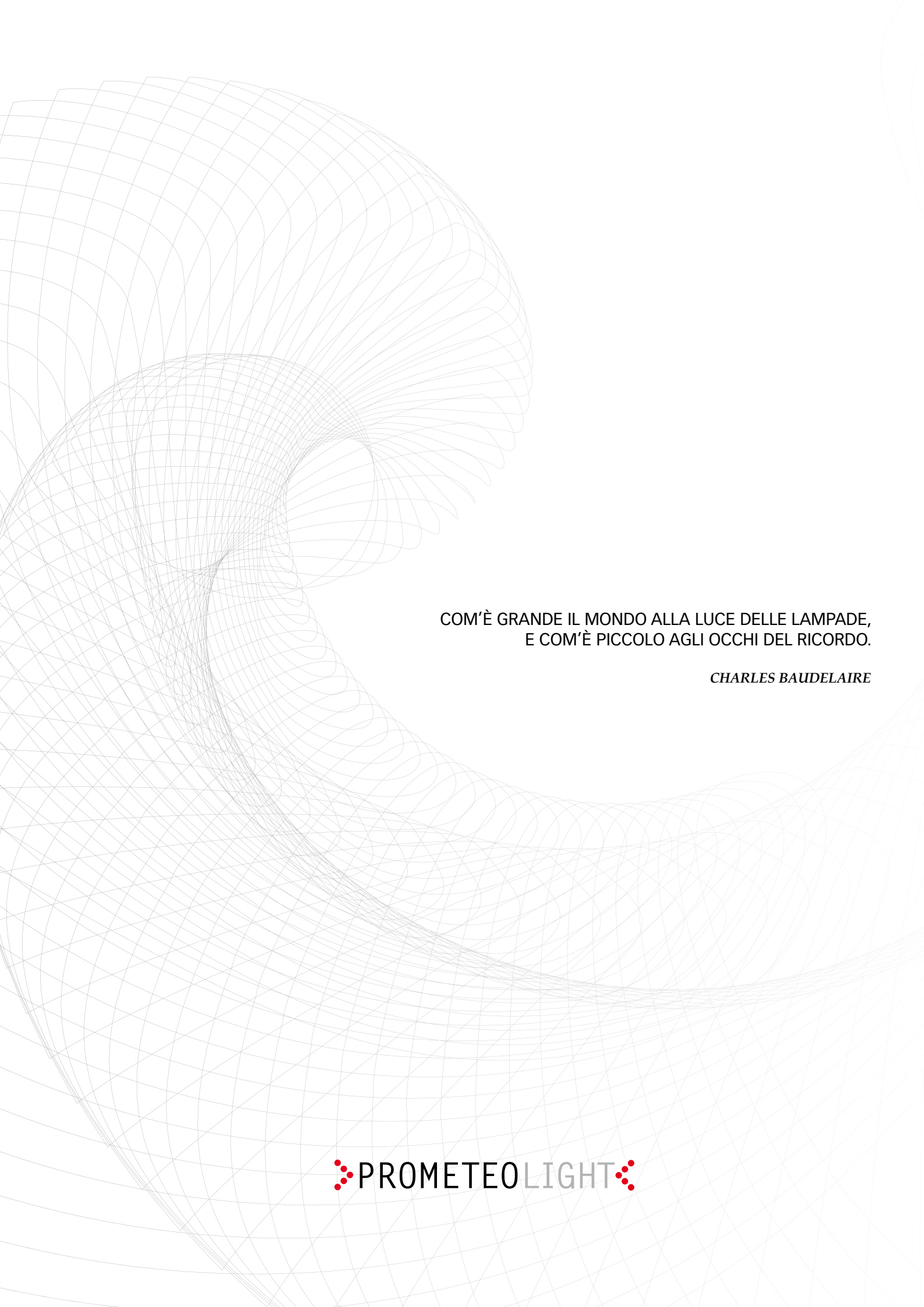
An abstract wireframe graphic of a human face, composed of numerous thin, overlapping lines that create a mesh-like structure. The face is shown in profile, looking towards the right, and is rendered in a light gray color. The lines are more densely packed in some areas, particularly around the eyes and nose, giving a sense of depth and texture. The overall effect is that of a digital or architectural model of a face.

COM'È GRANDE IL MONDO ALLA LUCE DELLE LAMPADE,
E COM'È PICCOLO AGLI OCCHI DEL RICORDO.

CHARLES BAUDELAIRE

 PROMETEO LIGHT 

Il design è il nostro mondo, il nostro stile, come si usa dire: la nostra vision.

I principi del design made in italy ci hanno sempre orientato e premiato, per questo, dopo 70 anni di presenza sul mercato, più che produttori di lampade preferiamo definirici: progettisti di soluzioni.

PROMETEO LIGHT, marchio specializzato nelle soluzioni innovative e ad alto valore tecnologico, per illuminare tutti quegli spazi dove la qualità della luce è un bisogno imprescindibile. Un marchio che concentra e specializza tutte le esperienze di ricerca avanzata, sviluppo e produzione del gruppo Valenti, che a partire dal 1985, con il sistema su cavi Miriade e dal 1997 con quello Omnia ha sintetizzato con successo competenza, creatività e performance di prodotto.

Ho usato molte volte la parola: specializzazione, perché oggi è indispensabile per affrontare con successo il complesso intreccio di problemi tecnici, normativi e di servizio che il mercato impone. Per questo PROMETEO LIGHT offre ai professionisti dell'illuminazione, soluzioni e servizi integrati tra loro. Una offerta che comprende la nostra disponibilità di sempre e ... nuovo entusiasmo.

Design is our world and our style: it is our vision.

Italian design principles have always guided and rewarded us. That is why after 70 years' trading we prefer to consider ourselves solution designers rather than lamp manufacturers.

PROMETEO LIGHT, product line that specialises in high-tech innovative solutions for lighting all those spaces where light quality is vital. A brand that concentrates and specialises all advance research, development and production of the Valenti Group, which since 1985 with the Mirade wire system and since 1997 with the Omnia system has encapsulated competence, creativity and product performance.

I have used the word 'specialisation' a lot because it is indispensable today for successfully tackling the complex problem of technical, standard and service problems that the market imposes. That is why PROMETEO LIGHT provides lighting professionals with integrated solutions and services. An offer that comprises our usual availability and our new enthusiasm.

Le design est notre monde, notre style et, comme on le dit souvent, notre vision.

Les principes du design italien nous ont toujours guidés et récompensés. C'est la raison pour laquelle, après 70 ans de présence sur le marché, plus que des producteurs de lampes, nous pensons être de véritables concepteurs de solutions.

PROMETEO LIGHT, marque spécialisée dans les solutions innovantes à haute valeur technologique, pour éclairer tous les espaces où la qualité de la lumière est un besoin auquel l'on ne saurait renoncer. Cette marque concentre et spécialise toutes les expériences de recherche avancée, de développement et de production du groupe Valenti qui, à partir de 1985, avec le système sur câbles Miriade et, à partir de 1997, avec Omnia, résume avec succès, la compétence, la créativité et les performances du produit.

J'ai souvent cité le mot «spécialisation». Aujourd'hui, cette vertu est indispensable pour affronter avec succès l'enchevêtrement complexe des problèmes techniques, normatifs et de service que le marché impose. C'est la raison pour laquelle PROMETEO LIGHT offre aux professionnels de l'éclairage, des solutions et des services intégrés. Une proposition qui se base sur notre éternelle disponibilité et sur un nouvel enthousiasme.

Das Design ist unsere Welt, unser Stil. Wie man so schön sagt, unsere Vision.

Die Prinzipien des Designs Made in Italy haben uns stets geleitet und belohnt. Aus diesem Grund sehen wir uns, nach 70 Jahren Marktpräsenz, nicht nur als Leuchtenhersteller, sondern vielmehr als Entwickler beleuchtungstechnischer Lösungen.

PROMETEO LIGHT, Marke für spezifische innovative Lösungen von hohem technologischen Wert zur Beleuchtung all jener Räume, in denen die Qualität des Lichts ein unumgängliches Bedürfnis ist. Eine Marke, die sämtliche Erfahrungen der modernen Forschung, Entwicklung und Produktion der Valenti-Gruppe, die mit den Kabelsystemen Miriade (1985) und Omnia (1997) erfolgreich Kompetenz, Kreativität und Produktperformance vereint, konzentriert und spezialisiert.

Oft habe ich das Wort Spezialisierung verwendet, denn sie ist heute unerlässlich, um die komplexe Verflechtung der Marktanforderungen in den Bereichen Technik, Normen und Service zu meistern. PROMETEO LIGHT bietet daher den Beleuchtungsprofis integrierte Lösungen und Services. Ein Angebot, das neben unserer bekannten Freundlichkeit neuen Enthusiasmus vermittelt.

El diseño es nuestro mundo, nuestro estilo, como suele decirse: nuestra visión.

Los principios del diseño made in italy nos han orientado y premiado siempre, por eso, tras 70 años de presencia en el mercado, más bien que productores de lámparas preferimos definirnos: proyectistas de soluciones.

PROMETEO LIGHT, marca especializada en las soluciones innovadoras y de alto valor tecnológico, para iluminar todos aquellos espacios donde la calidad de la luz es una necesidad imprescindible. Una marca que concentra y especializa todas las experiencias de investigación avanzada, desarrollo y producción del grupo Valenti, que a partir de 1985, con el sistema sobre cables Miriade y desde 1997 con el sistema Omnia ha sintetizado con éxito competencia, creatividad y rendimiento del producto.

He utilizado muchas veces la palabra: especialización, porque hoy es indispensable para enfrentar con éxito el complejo conjunto de problemas técnicos, normativos y de servicio que el mercado impone. Por eso PROMETEO LIGHT proporciona a los profesionistas de la iluminación, soluciones y servicios integrados entre ellos. Una oferta que incluye nuestra disponibilidad de siempre y ... nuevo entusiasmo.

FINITURE - FINISHING

- AG AG** Argento metallizzato
Silver metallic
- AL AL** Alluminio anodizzato
Anodized aluminium
- AM AM** Ambra
Amber
- AR AR** Arancio
Orange
- AT AT** Alluminio
Aluminium
- AZ AZ** Azzurro
Light-blue
- BI BI** Bianco
White
- BL BL** Blu
Blue
- BO BO** Bianco opaco
Matt white
- CI CI** Ciliegio
Cherry
- CR CR** Cromato
Chrome
- GA GA** Grigio antracite
Grey anthracite
- GI GI** Giallo
Yellow
- GL GL** Grigio metallizzato lucido
Bright grey metallic
- GM GM** Grigio metallizzato
Grey metallic
- GS GS** Grigio metallizzato scuro
Dark grey metallic
- IM IM** Inox specchio
Mirror inox
- IN IN** Inox lucido
Inox bright
- IS IS** Inox satinato
Inox satined
- MO MO** Metallo satinato
Satined metal
- NE NE** Nero
Black
- NI NI** Nickel
- NL NL** Nero lucido
Bright black
- NS NS** Nickel satinato
Satined nickel
- OR OR** Oro
Gold
- RA RA** Rame
Copper plated
- RO RO** Rosso
Red
- RR RR** Rosso rubino
Ruby-red
- RS RS** Rosa
Pink
- SA SA** Vetro satinato
Satined glass
- SE SE** Vetro serigrafato
Screen-printed glass
- TR TR** Trasparente
Transparent
- VE VE** Verde
Green
- WE WE** Wengè
- XX XX** Senza finitura
Without finishing

SIMBOLI - SYMBOL

- CE** Tutti i prodotti che rientrano nell'ambito di applicazione della direttiva europea 2006/95/CE soddisfano i requisiti e recano la marcatura CE. Il simbolo CE è posto sull'imballo del prodotto e nel foglio istruzioni. All the products meet with current European directives 2006/95/CE satisfy their requirement and are CE marked. The symbol CE is placed on the product packaging and on the data sheet.
- IT** Istituto Italiano del Marchio di Qualità
Italian conformity seal
- UE** Marchio Unificato Europeo
Unified European Trade mark
- DE** Marchio di conformità tedesco
German conformity seal
- S** Marchio di conformità svedese
Swedish conformity seal
- N** Marchio di conformità norvegese
Norwegian conformity seal
- D** Marchio di conformità danese
Danish conformity seal
- USA** Marchio di conformità americano
American conformity seal
- CA** Marchio di conformità canadese
Canadian conformity seal
- ⊕** Contatto di terra - Classe I
Earth contact - Class I
- Doppio isolamento Classe II
Double insulation - Class II
- III** Bassissima tensione di sicurezza - Classe III
Very low safety voltage - Class III
- IP20** Protezione contro l'ingresso di corpi solidi Ø >= 12 mm.
Protection against the penetration of solid bodies Ø >= 12 mm.
- IP40** Protezione contro l'ingresso di corpi solidi Ø >= 1 mm.
Protection against the penetration of solid bodies Ø >= 1 mm.
- IP43** Protezione contro l'ingresso di corpi solidi Ø >= 1 mm. e contro la pioggia
Protection against the penetration of solid bodies Ø >= 1 mm. and against the rain
- IP45** Protezione contro l'ingresso di corpi solidi Ø >= 1 mm. e contro i getti d'acqua
Protection against the penetration of solid bodies Ø >= 1 mm. and water jet
- IP54** Protezione contro l'ingresso della polvere e contro gli spruzzi d'acqua
Protected against the penetration of dust and water splash
- IP55** Protezione contro l'ingresso della polvere e contro i getti d'acqua
Protected against the penetration of dust and water splash
- IP65** Protezione completa contro l'ingresso di corpi solidi e contro getti d'acqua
Completely protected against the penetration of solid bodies and against jets of water
- IP66** Protetto completamente contro la penetrazione della polvere e di ondate
Completely dust proof and protected from heavy water collision
- IP68** Protezione completa contro la penetrazione della polvere e stagno alla sommersione
Fully protected against dust penetration and submersion
- F** Montaggio diretto su superfici infiammabili
Direct mounting on normally flammable surfaces
- M** Installabile su mobili
For installation of furniture
- 0,3m** Distanza minima dagli oggetti illuminati
Minimum distance from illuminated objects
- 750°**
- 850°** Resistenza al filo incandescente
Resistance to incandescent wire
- 960°**
- ⊕** Trasformatore di sicurezza
Safety transformer
- ⊘** Diametro foro incasso
Hole downlight
- ⊘** Foro incasso
Hole downlight
- ⤴** Angolo di basculamento
Adjustment angle
- ⤴** Angolo di rotazione
Rotation angle
- ↻** Rotazione intorno all'asse orizzontale
Rotation adjustability on horizontal axis
- EL** Alimentatore elettronico
Electronic power supply
- MP** Multipotenza
Multipower
- DALI** Regolazione digitale con interfaccia DALI
Digital regulation with interface DALI
- 1-10** Regolazione analogica
Analogic regulation
- ⏏** Variatore intensità luminosa per lampade alogene
Light dimmer for halogen lamps
- ⏏** Connessione fila continua max 2500W
Continuous light line max 2500W
- RC** Telecomando ad infrarossi
Infrared remote control
- ES** Risparmio energetico
Energy saver
- ☀** Lampadina inclusa
bulb included
- ✖** Solo su richiesta
Only on request
- Articolo in esaurimento
Item to be phased out

Nota: le potenze delle lampade indicate a catalogo vanno intese come potenza massima utilizzabile.
Note: the power values of the lamps indicated in this catalogue are maximum power ratings.

- FL** Lampadina fluorescente lineare
Linear fluorescent bulb
- FC** Lampadina fluorescente circolare
Circular fluorescent bulb
- INC** Incandescenza
Incandescent
- A.M.** Alogenuri Metallici
Metal Halide
- ALO** Alogena
Halogen

GUIDA ALLA CONSULTAZIONE - REFERENCE GUIDE

NOME PRODOTTO
PRODUCT NAME

DESIGNER

ANNO DI PRODUZIONE
DATE OF PRODUCTION

DESCRIZIONE PRODOTTO
PRODUCT DESCRIPTION

INFORMAZIONI TECNICHE
TECHNICAL INFORMATION

..... DISEGNO TECNICO in cm.
TECHNICAL DRAWING in inches

OMNIA EGG PARETE HQI	CODE	DESCRIPTION	NOTES	KG/LBS
	110700GM	1 x 70W 2 vetri sabbati 2 sanded glasses	110960XX A.M. MT 70W 230V G8.5	1,8/4
	110710GM	1 x 70W vetro sabbato + riflettore 1 sanded glass + reflector		1,57/3,5

FINITURE vedi pag. 04
FINISHING see page 04

110710GM
LEGENDA FINITURE vedi pag. 04
LIST OF FINISHING see page 04

- TIPOLOGIA CABLAGGIO
CABLING
- 0** = ITALIA/EUROPA
ITALY/EUROPE
 - 1** = STATI UNITI
U.S.A.
 - 2** = SVIZZERA
SWITZERLAND
 - 4** = FRANCIA/GERMANIA
FRANCE/GERMANY
 - 5** = REGNO UNITO
UNITED KINGDOM

CODICE PRODOTTO
PRODUCT CODE

SIMBOLI vedi pag. 04
SYMBOLS see page 04

TIPO DI LAMPADINA vedi pag. 143
BULB TYPE see page 143

PESO
WEIGHT

FOTOMETRIE
PHOTOMETRICS



LAMPADE 8

SISTEMA MANDARIN 50

INCASSI 60

SISTEMA EMME E SISTEMA MINI EMME 12V 68

SISTEMA OMNIA FILO 230V 98

SISTEMA MONOCAVO 230V 124

SISTEMA D CAVO 230V 134



ALA
PARETE
SOFFITTO **10**

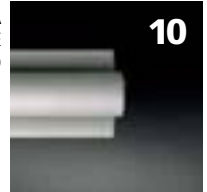

APPEAL
PARETE **12**



CUBETTO
PARETE **14**



D TECH
PARETE
SOFFITTO **16**



D TECH FLUO
PARETE
SOFFITTO
SOSPENSIONE **20**

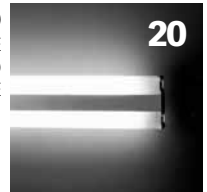

EGG
PARETE
SOFFITTO
SOSPENSIONE **22**



FERROSETTE
TERRA **26**

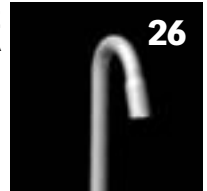

GEOLIGHT
PARETE **28**



LENS 30-40
PARETE
SOFFITTO **30**

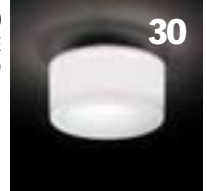

MONOPARETE
PARETE **32**



OMNIA
PARETE **34**



OMNIA ECO
PARETE
SOSPENSIONE **36**



OMNIA E27 HQI
PARETE **38**

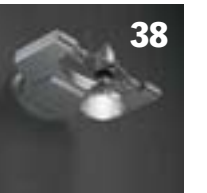

OMNIA EGG HQI
PARETE **39**

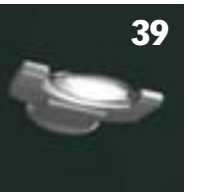

OMNIA GLASS
PARETE
SOFFITTO **40**



OMNIA SPOT E27
PARETE
SOFFITTO **42**



PROMENADE
PARETE
SOFFITTO
SOSPENSIONE **44**



SUN
SOSPENSIONE **46**



XSQUARE
PARETE
SOFFITTO **48**





Lampada da parete o soffitto, dotata di un riflettore orientabile per ottenere effetti di luce diffusa con emissione graduabile dai due lati. Montabile a parete sia orizzontalmente che verticalmente, anche con più elementi accostati, collegabili meccanicamente e elettricamente tra loro. Realizzata in estruso di alluminio verniciato. Facilmente smontabile per permettere una facile installazione e una rapida manutenzione. Utilizza lampade fluorescenti ad alta efficienza alimentate elettronicamente per una resa luminosa ottimale e totalmente priva di oscillazioni.

Wall or ceiling lamp, featuring a swivel reflector to obtain diffused light effects with gradual emission from two sides. Can be horizontally or vertically wall mounted, including with several elements placed one beside the other and connected together mechanically and electrically. Made of extruded aluminium. Can be easily dismantled for easier installation and quick maintenance. Uses high-efficiency fluorescent bulbs electronically supplied for a perfect light yield totally without oscillations.

Applique ou plafonnier, doté d'un réflecteur pivotant pour obtenir des effets de lumière diffuse avec une émission qui peut être graduée des deux côtés. Installation murale tant horizontalement que verticalement, même avec plusieurs éléments associés que l'on peut relier entre eux mécaniquement et électriquement. Réalisé en extrudé aluminium.

Facilement démontable pour une installation facile et un entretien rapide. Utiliser des ampoules fluorescentes à haut rendement, alimentées électroniquement pour un rendu lumineux optimal et totalement dépourvu d'oscillations.

Wand- oder Deckenleuchte mit drehbarem Schirm für diffuse Lichteffekte mit beidseitig abstuftbarer Abgabe.

Die Wandmontage kann horizontal oder vertikal erfolgen, auch mit mehreren mechanisch und elektrisch zu verbindenden Elementen. Hergestellt aus fließgepreßtem Eloxal. Einfach zerlegbar für eine leichte Installation und schnelle Wartung. Verwendbar mit Leuchtstofflampen mit hoher Lichtausbeute und elektronischer Speisung, vollständig schwankungsfrei.

Lampara de pared o techo, dotada de pantalla giratoria para obtener efectos de luz difundida con emisión graduable por los dos lados.

Se puede montar en la pared sea horizontal que verticalmente, también con otros elementos acoplados, conectables mecánica y eléctricamente entre ellos. Realizada en extruido de aluminio. Fácil de desmontar para permitir una cómoda instalación y un rápido mantenimiento. Utiliza bombillas fluorescentes de alta eficiencia alimentadas electrónicamente para un rendimiento luminoso óptimo y totalmente privo de oscilaciones.

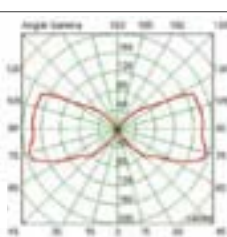
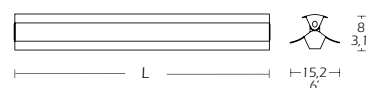

109040... 1 x 54W

ALA PARETE/SOFFITTO	CODE	DESCRIPTION	NOTES	KG/LBS
	109020GM	L = 60/23,6' 1 x 24W	 109060XX FL FQ T5 24W 230V G5 T16	1,60/3,5
	109030GM	L = 90/35,4' 1 x 39W	 109070XX FL FQ T5 39W 230V G5 T16	2,20/4,9
	109040GM	L = 120/47,2' 1 x 54W	 109080XX FL FQ T5 54W 230V G5 T16	2,80/6,2
	109050GM	L = 150/59' 1 x 80W	 109090XX FL FQ T5 80W 230V G5 T16	3,40/7,5

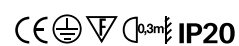
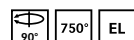



			537020.. 1 x 26W	
APPEAL 35	CODE	DESCRIPTION	NOTES	KG/LBS
	537010BI 537010IN 537010IS	ALO 1 x 120W	 108080XX ALO HDG 100W 230V R7s-74.9 QT-DE 108210ES ALO HDG 120W 230V R7s-74.9 ES	2,17/4,8
	537020BI 537020IN 537020IS	FLUO 1 x 26W	 112300XX FL FSQ 26W 230V G24 q-3 TC-DE	1,58/3,5
APPEAL 70	CODE	DESCRIPTION	NOTES	KG/LBS
	537030BI 537030IN 537030IS	ALO 2 x 120W	 108080XX ALO HDG 100W 230V R7s-74.9 QT-DE 108210ES ALO HDG 120W 230V R7s-74.9 ES	3,69/8,1
	537040BI 537040IN 537040IS	FLUO 2 x 24W	 109060XX FL FQ 24W 230V G5 T16	3,2/6,7
	537050BI 537050IN 537050IS	FLUO 1 x 80W	 112170XX FL FSD 80W 230V 2G11 TC-L	2,92/6,4
APPEAL 130	CODE	DESCRIPTION	NOTES	KG/LBS
	537060BI 537060IN 537060IS	FLUO 2 x 54W	 109080XX FL FQ 54W 230V G5 T16	6,93/15,3
	537070BI 537070IN 537070IS	FLUO 2 x 80W	 112170XX FL FSD 80W 230V 2G11 TC-L	6,82/15
	537100BI 537100IN 537100IS	FLUO 2 x 54W	 109080XX FL FQ 54W 230V G5 T16 110980XX FL FH 28W 230V G5 T16	
	537090BI 537090IN 537090IS	FLUO 2 x 80W	 112170XX FL FSD 80W 230V 2G11 TC-L	



Lampada da parete.
Struttura in acciaio verniciato bianco.
Diffusori in vetro borosilicato satinato.
Frontale in acciaio in differenti versioni:
bianco opaco, inox lucido, inox satinato
spazzolato.

Wall lamp. Steel frame white painted.
Borosilicate glass diffuser satinated finishing.
Steel front face in different versions:
matt white, bright inox, satined inox.











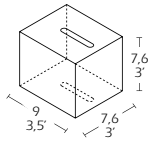



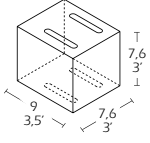

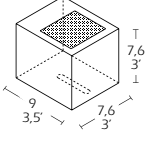

Applique avec structure en acier verni blanc.
Diffuseur en verre borosilicate satiné.
Section frontale en acier.
Différentes versions: blanc opaque,
inox poli, inox satiné brossé.

Wandleuchte mit lackiertem weiß Stahl
Aufbau. Diffusor aus satiniert Borsilikat
Glas. Frontal-Seite aus Stahl. In verschiedene
Versionen: weiß matt, inox glänzend, inox
satiniert gebürstet.

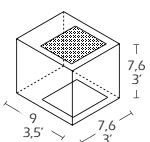
Applique de pared.
Estructura de acero pintado en blanco.
Difusores de vidrio borosilicato satinado.
Parte frontal de acero en versiones
diferentes: blanco mate, acero inoxidable
brillante, acero inoxidable satinado cepillado.





				
CUBETTO T1	CODE XFWL36GM	DESCRIPTION 1 x 40W 2 tagli 2 cuts	NOTES  110400XX ALO HSGST 40W 230V G9	KG/LBS 0,28/0,6
				
CUBETTO T2	CODE XFWL37GM	DESCRIPTION 1 x 40W 4 tagli 4 cuts	NOTES  110400XX ALO HSGST 40W 230V G9	KG/LBS 0,27/0,6
				
CUBETTO TV	CODE XFWL38GM	DESCRIPTION 1 x 40W 1 vetro + 1 taglio 1 glass + 1 cut	NOTES  110400XX ALO HSGST 40W 230V G9	KG/LBS 0,29/0,6
				
CUBETTO V2	CODE XFWL38BGM	DESCRIPTION 1 x 40W 2 vetri 2 glasses	NOTES  110400XX ALO HSGST 40W 230V G9	KG/LBS 0,3/0,7
	   IP20			



Lampada da parete alogena.
Struttura in pressofusione d'alluminio
verniciata grigio.

Halogen wall lamp.
Structure made of die cast aluminium
grey painted.

Applique halogène.
Structure en aluminium verni gris.

Halogen Wandleuchten.
Körper aluminium Grau lackiert.

Lampara halogena de pared.
Estructura en aluminio barnizado gris.



E' l'estensione tecnica della serie D: sorgenti luminose e gran parte dei componenti corrispondono a quelli utilizzati nella D CAVO. Comprende sospensioni e apparecchi singoli e multipli per l'illuminazione diffusa e concentrata.

Technical extension of the serie D: lighting sources and a big part of the components correspond to those used for D CAVO. It includes suspensions and single-multiple appliances for a diffused and concentrated lighting.

Extension technique de la gamme D: la plus part des lampes et des composants correspondent à ceux utilisés pour D CAVO. Cette série offre des suspensions, des appareils uniques ou multiples pour l'éclairage diffus ou concentré.

Das technisch Ausdehnen die serie D: Leuchtenkörpern und Verschiedene Komponente, sind die gleiche gebraucht für D Cavo.

Es enthält Aufhängung, einzeln und vielfachen Apparat für eine verbreitete und konzentrierte Beleuchtung.

Extensión técnica de la serie D: la mayor parte de los componentes corresponden a los utilizados en la D CAVO. Comprende suspensiones y aparatos simples y múltiples para la iluminación difusa y concentrada.

D TECH ALO S	CODE 522380CR	DESCRIPTION 1 x 150W	NOTES 108210XX ALO HDG 150W 230V R7s 74.9 QT-DE 108210ES ALO HDG 120W 230V R7s-74.9 ES	KG/LBS 1/2,2
D TECH ALO D	CODE 522390CR	DESCRIPTION 2 x 150W	NOTES 108210XX ALO HDG 150W 230V R7s 74.9 QT-DE 108210ES ALO HDG 120W 230V R7s-74.9 ES	KG/LBS 2/4,4
D TECH ALO T	CODE 522400CR	DESCRIPTION 3 x 150W	NOTES 108210XX ALO HDG 150W 230V R7s 74.9 QT-DE 108210ES ALO HDG 120W 230V R7s-74.9 ES	KG/LBS 1,92/4,2

D TECH ALO S2	CODE 522780CR	DESCRIPTION 1 x 200W 2 vetri + riflettore alluminio 2 glasses + aluminium reflector	NOTES 108270XX ALO HDG 200W 230V R7s 114.2 QT-DE 108270ES ALO HDG 160W 230V R7s 114.2 ES	KG/LBS 0,94/2,1
D TECH ALO S2-3	CODE 522790CR	DESCRIPTION 1 x 200W vetro trasparente + vetro sabbato + riflettore alluminio transparent glass + sanded glass + aluminium reflector	NOTES 108270XX ALO HDG 200W 230V R7s 114.2 QT-DE 108270ES ALO HDG 160W 230V R7s 114.2 ES	KG/LBS 1,13/2,5



D TECH SPOT S	CODE 522410CR	DESCRIPTION 1 x 150W	NOTES 111710XX ALO HAGS 50W 230V E27 PAR20 111670XX ALO HAGS 75W 230V E27 PAR30	KG/LBS 1/2,2
D TECH SPOT D	CODE 522420CR	DESCRIPTION 2 x 150W	NOTES 111710XX ALO HAGS 50W 230V E27 PAR20 111670XX ALO HAGS 75W 230V E27 PAR30	KG/LBS 2/4,4
D TECH SPOT T	CODE 522430CR	DESCRIPTION 3 x 150W	NOTES 111710XX ALO HAGS 50W 230V E27 PAR20 111670XX ALO HAGS 75W 230V E27 PAR30	KG/LBS 3/6,6

D TECH ALO + SPOT	CODE 522740CR	DESCRIPTION 2 x 150W	NOTES 108210XX ALO HDG 150W 230V R7s 74.9 QT-DE 108210ES ALO HDG 120W 230V R7s-74.9 ES 111710XX ALO HAGS 50W 230V E27 PAR20 111670XX ALO HAGS 75W 230V E27 PAR30	KG/LBS 2/4,4
D TECH 2 ALO + SPOT	CODE 522760CR	DESCRIPTION 3 x 150W	NOTES 108210XX ALO HDG 150W 230V R7s 74.9 QT-DE 108210ES ALO HDG 120W 230V R7s-74.9 ES 111710XX ALO HAGS 50W 230V E27 PAR20 111670XX ALO HAGS 75W 230V E27 PAR30	KG/LBS 3/6,6
D TECH 2 SPOT + ALO	CODE 522750CR	DESCRIPTION 3 x 150W	NOTES 108210XX ALO HDG 150W 230V R7s 74.9 QT-DE 108210ES ALO HDG 120W 230V R7s-74.9 ES 111710XX ALO HAGS 50W 230V E27 PAR20 111670XX ALO HAGS 75W 230V E27 PAR30	KG/LBS 3/6,6

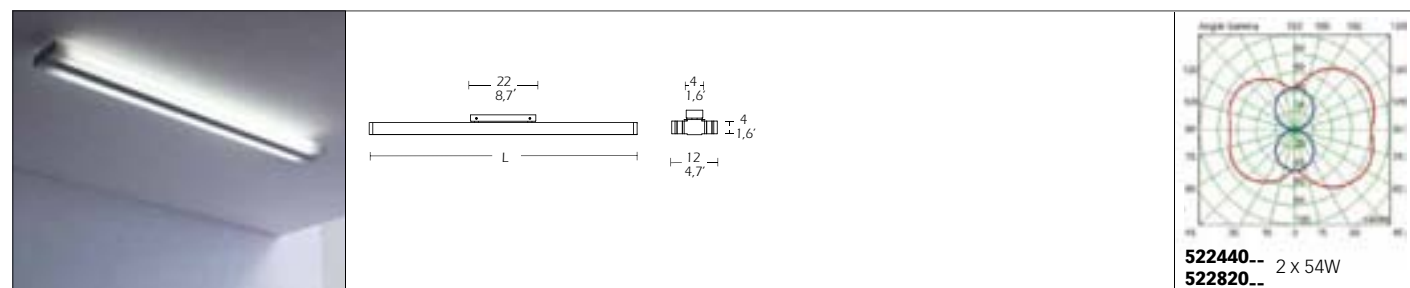

D TECH FLUO PARETE/SOFFITTO	CODE	DESCRIPTION	NOTES	KG/LBS
522670BI 522670GM 522670IN	L = 90/35.4'	2 x 21W/39W	1-10 110390XX FL FH 21W 230V G5 T16 109070XX FL FQ 39W 230V G5 T16	2,74/6
	522830BI 522830GM 522830IN	L = 90/35.4'		
522440BI 522440GM 522440IN	L = 120/47.2'	2 x 28W/54W	1-10 110980XX FL FH 28W 230V G5 T16 109080XX FL FQ 54W 230V G5 T16	3,4/7,5
	522820BI 522820GM 522820IN	L = 120/47.2'		
522930BI 522930GM 522930IN	L = 150/59.0'	2 x 35W/80W	1-10 110950XX FL FH 35W 230V G5 T16 109090XX FL FQ 80W 230V G5 T16	5,3/11,7
	522950BI 522950GM 522950IN	L = 150/59.0'		

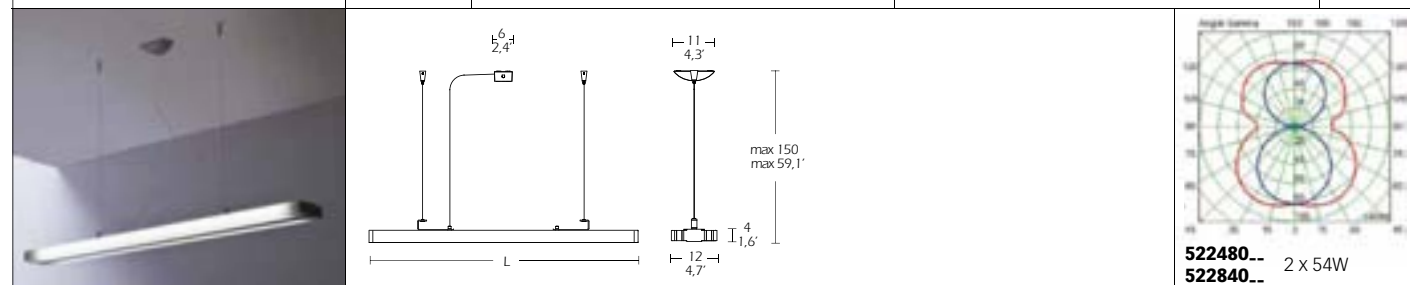

D TECH FLUO SOSPENSIONE	CODE	DESCRIPTION	NOTES	KG/LBS
522680BI 522680GM 522680IN	L = 90/35.4'	2 x 21W/39W	1-10 110390XX FL FH 21W 230V G5 T16 109070XX FL FQ 39W 230V G5 T16	2,3/5,1
	522850BI 522850GM 522850IN	L = 90/35.4'		
522480BI 522480GM 522480IN	L = 120/47.2'	2 x 28W/54W	1-10 110980XX FL FH 28W 230V G5 T16 109080XX FL FQ 54W 230V G5 T16	3/6,6
	522840BI 522840GM 522840IN	L = 120/47.2'		
522940BI 522940GM 522940IN	L = 150/59.0'	2 x 35W/80W	1-10 110950XX FL FH 35W 230V G5 T16 109090XX FL FQ 80W 230V G5 T16	4,9/10,8
	522960BI 522960GM 522960IN	L = 150/59.0'		

BI GM IN

ES EL 850° MP

CE IP20



Lampada fluorescente da parete, soffitto e sospensione.
Struttura in acciaio verniciato oppure in acciaio inox.
Diffusore in policarbonato opalino bianco. Finiture grigio metallizzato, bianco opaco e acciaio inox lucido. Alimentatore elettronico multi potenza. Potenze da 39 a 80W. Versione con emergenza su richiesta.

Wall-ceiling and hanging fluorescent lamp.
Painted or stainless steel frame.
White opaline polycarbonate diffuser.
Grey metallic, matt white or bright stainless steel frame finishing. Multi-power ballast. Sizes from 39 to 80W. Emergency set version on request.







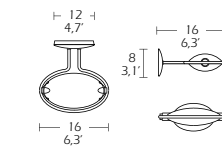

Suspension avec ampoule fluorescente, diffuseur en polycarbonate opalin.
Structure en acier. Finitions chromé et gris métallisé. Applique, plafonnier et suspension fluorescent.
Structure en acier verni ou acier inox.
Diffuseur en polycarbonate opale blanc. Finitions gris métallisé, blanc opaque et acier inox poli. Alimentateur électronique multi-puissance de 39 au 80W. Version avec urgence sur demande.

Leuchtstofflampe mit diffusor aus opalem weiß Polykarbonat.
Aufbau aus Aluminium.
Chrom/verchromt und silber ausführung.
Wand-Decke-Haengeleuchte fluoreszent.
Aufbau aus lackiertem oder Inox Stahl.
Opal weiss Polykarbonat Diffusor
Ausfuehrungen silber, weiss matt und inox glaenzend Stahl.
Version mit Notfall auf Nachfrage.

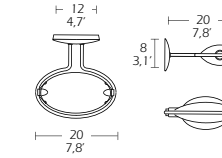
Lampara fluorescente en las versiones de pared, techo y suspensión. Estructura en acero barnizado blanco o bien en acero inox. Difusor en policarbonato opal blanco. Balasto electrónico multi potencia. Potencia desde 39 a 80W. Version con emergencia sobre demanda.

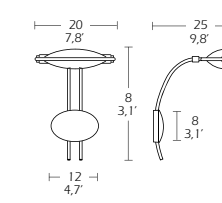

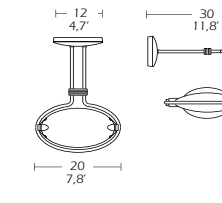



				
EGG 16	CODE	DESCRIPTION	NOTES	KG/LBS
	107810CR	1 x 100W 2 vetri sabbiati 2 sanded glasses	 108080XX ALO HDG 100W 230V R7s-74.9 QT-DE 108080ES ALO HDG 80W 230V R7s-74.9 ES	0,42/0,9
	107820CR	1 x 100W vetro sabbiato + riflettore sanded glass + reflector		
				
EGG 20	CODE	DESCRIPTION	NOTES	KG/LBS
	107830CR	1 x 200W 2 vetri sabbiati 2 sanded glasses	 108270XX ALO HDG 200W 230V R7s-114.2 QT-DE 108270ES ALO HDG 160W 230V R7s-114.2 ES	0,5/1,1
	107840CR	1 x 200W vetro sabbiato + riflettore sanded glass + reflector		
				
EGG 20 PARETE	CODE	DESCRIPTION	NOTES	KG/LBS
	107870CR	1 x 200W 2 vetri sabbiati 2 sanded glasses	 108270XX ALO HDG 200W 230V R7s-114.2 QT-DE 108270ES ALO HDG 160W 230V R7s-114.2 ES	0,5/1,1
	107880CR	1 x 200W vetro sabbiato + riflettore sanded glass + reflector		
				
EGG 20 TIGE	CODE	DESCRIPTION	NOTES	KG/LBS
	107850CR	1 x 200W 2 vetri sabbiati 2 sanded glasses	 108270XX ALO HDG 200W 230V R7s-114.2 QT-DE 108270ES ALO HDG 160W 230V R7s-114.2 ES	0,5/1,1
	107860CR	1 x 200W vetro sabbiato + riflettore sanded glass + reflector		

CR

ES

CE    IP20

Lampada da parete e soffitto, struttura cromata e diffusori in vetro satinato bianco. Versione sospensione a quattro braccia.

Chromed structure wall and ceiling lamp, matt white glass diffusers.
Hanging lamp with four chromium-plated arms.

Applique et plafonnier structure chromé, diffuseurs en verre satiné blanc.
Plafonnier à quatre bras chromé.

Aufbau verchromt, Wand- bzw. Deckenleuchte aus weiß satiniertem Glas.
Deckenleuchte mit vier verchromten Armen.

Lampara de pared o techo en estructura cromada y cristal opaco blanco.
Lampara de techo de quatro brazos cromados.



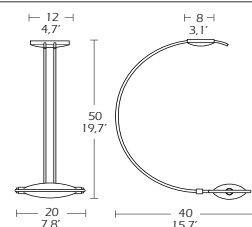



EGG 20 SOFFITTO	CODE	DESCRIPTION	NOTES	KG/LBS
	107890CR	1 x 200W 2 vetri sabbatiati/2 sanded glasses	 108270XX ALO HDG 200W 230V R7s-114.2 QT-DE 108270ES ALO HDG 160W 230V R7s-114.2 ES	0,8/1,8
	107900CR	1 x 200W vetro sabbatiato + riflettore sanded glass + reflector		

CR

ES

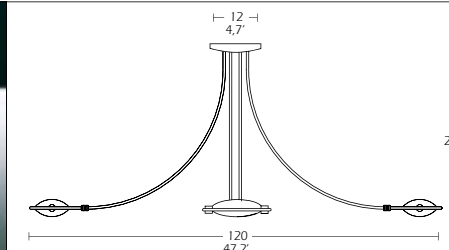

 IP20

EGG SOSPENSIONE	CODE	DESCRIPTION	NOTES	KG/LBS
	108530CR	4 x 200W 2 vetri sabbatiati x 4 lampade 2 sanded glasses x 4 lamps	 108270XX ALO HDG 200W 230V R7s-114.2 QT-DE 108270ES ALO HDG 160W 230V R7s-114.2 ES	3,7/8,2

CR

ES



 IP20



Lampada da terra per esterno.
Struttura in acciaio verniciato.
Diffusore con vetro di protezione
incorporato.
Sorgente luminosa a Led.
Finiture grigio metallizzato lucido,
grigio antracite.

Outdoor floor lamp. Painted steel frame.
Diffuser with protection glass included.
Light source Led.
Bright grey metallic and grey anthracite
finishing.

Lampadaire pour extérieur.
Structure en acier.
Diffuseur avec verre de protection inclus.
Source lumineuse a Led.
Finissage gris métallisé poli et gris
anthracite.

Außen Stehleuchte. Stahl Aufbau lackiert.
Diffusor mit Schutzglas eingliedert.
Lichtwelle Led.
Ausführungen silber glänzend und anthrazit.

Luminaria de exterior.
Estructura de acero pintado.
Difusor con cristal de protección
incorporado.
Fuente de luz de Led.
Acabados gris metalizado brillante,
gris antracita.



FERROSETTE	CODE	DESCRIPTION	NOTES	KG/LBS
	539010GA 539010GL	H = 163/64,2'	LED 3 x 2W - 3000° K	6/13,2
	539020GA 539020GL	H = 73/28,7'	LED 3 x 1W - 3000° K	3,5/7,7
	539030GA 539030GL	H = 48/18,9'	LED 3 x 1W - 3000° K	2,8/6,2
GA GL			EL ES	
	539090GA 539090GL	picchetto con flangia picket with flange		1,1/2,4
	539070GA 539070GL	flangia di base base flange		0,7/1,5
	539080ZI	tiranti di fissaggio con dima di posizionamento finitura zincata fixing rods kit with zinc plated positioning template		0,3/0,7



<p>GEOLIGHT ALO</p>	<table border="1"> <thead> <tr> <th>CODE</th> <th>DESCRIPTION</th> <th>NOTES</th> <th>KG/LBS</th> </tr> </thead> <tbody> <tr> <td>ROUND 535010BI 535010GM 535010OR</td> <td>1 x 150W</td> <td> 108210XX ALO HDG 150W 230V R7s-74.9 QT-DE 108210ES ALO HDG 120W 230V R7s-74.9 ES </td> <td>1,2/2,6</td> </tr> <tr> <td>SQUARE 535020BI 535020GM 535020OR</td> <td></td> <td></td> <td></td> </tr> <tr> <td>STICK 535030BI 535030GM 535030OR</td> <td></td> <td></td> <td></td> </tr> </tbody> </table>	CODE	DESCRIPTION	NOTES	KG/LBS	ROUND 535010BI 535010GM 535010OR	1 x 150W	 108210XX ALO HDG 150W 230V R7s-74.9 QT-DE 108210ES ALO HDG 120W 230V R7s-74.9 ES	1,2/2,6	SQUARE 535020BI 535020GM 535020OR				STICK 535030BI 535030GM 535030OR			
CODE	DESCRIPTION	NOTES	KG/LBS														
ROUND 535010BI 535010GM 535010OR	1 x 150W	 108210XX ALO HDG 150W 230V R7s-74.9 QT-DE 108210ES ALO HDG 120W 230V R7s-74.9 ES	1,2/2,6														
SQUARE 535020BI 535020GM 535020OR																	
STICK 535030BI 535030GM 535030OR																	
<p>GEOLIGHT ECO</p>	<table border="1"> <thead> <tr> <th>CODE</th> <th>DESCRIPTION</th> <th>NOTES</th> <th>KG/LBS</th> </tr> </thead> <tbody> <tr> <td>ROUND 535040BI 535040GM 535040OR</td> <td>1 x 27W</td> <td> 112090XX FL FBT 27W 230V E27 </td> <td>1,7/3,7</td> </tr> <tr> <td>SQUARE 535050BI 535050GM 535050OR</td> <td></td> <td></td> <td></td> </tr> <tr> <td>STICK 535060BI 535060GM 535060OR</td> <td></td> <td></td> <td></td> </tr> </tbody> </table>	CODE	DESCRIPTION	NOTES	KG/LBS	ROUND 535040BI 535040GM 535040OR	1 x 27W	 112090XX FL FBT 27W 230V E27	1,7/3,7	SQUARE 535050BI 535050GM 535050OR				STICK 535060BI 535060GM 535060OR			
CODE	DESCRIPTION	NOTES	KG/LBS														
ROUND 535040BI 535040GM 535040OR	1 x 27W	 112090XX FL FBT 27W 230V E27	1,7/3,7														
SQUARE 535050BI 535050GM 535050OR																	
STICK 535060BI 535060GM 535060OR																	

BI GM OR

ES

CE

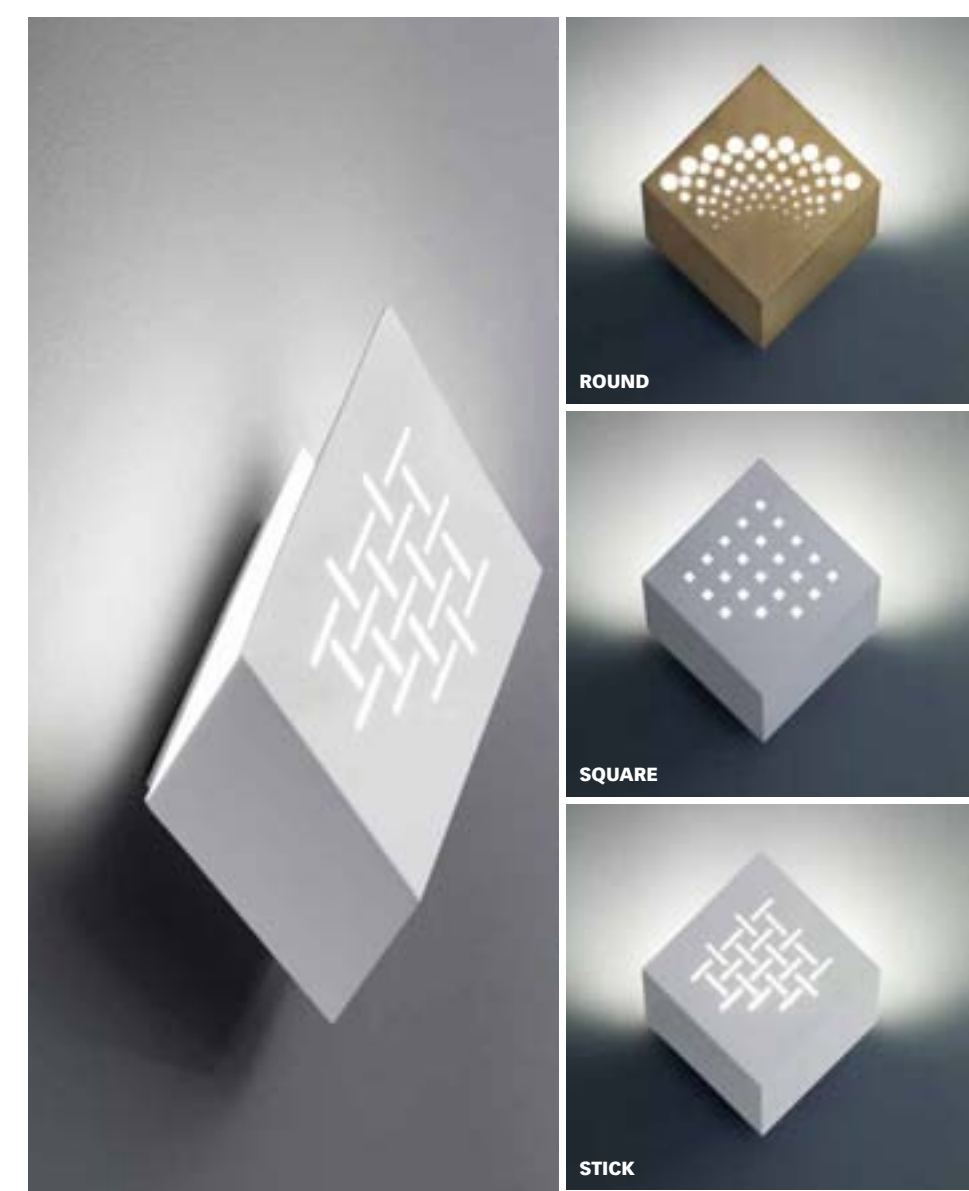

Lampada da parete in metallo.
Finitura superficiale verniciata nelle tinte grigio metallizzato, bianco e con un innovativo trattamento di doratura che rende la superficie rugosa.

Metal wall lamp.
Superficial finish painted in grey metallized, white and with a new gilding treatment which gives the surface wrinkly.

Applique en metal.
Finition couche vernie en gris metallisé, blanc et avec un innovateur traitement de dorure qui rende la surface ridee.

Metall Wand Leuchte.
Oberflaechlich Vollendung lackiert in silber, weiß oder mit eine neue vergoldung bearbeitung dass gibt die Oberflaeche runzelig.

Lampara de pared en metal.
Acabado superficial barnizado gris metalizado, blanco y con un tratamiento de doradura que devolve la superficie rugosa.













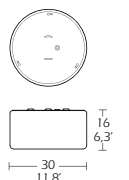
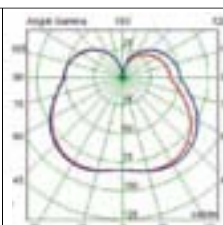

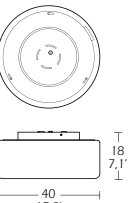
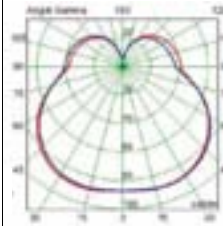

Lampada fluorescente da parete e soffitto ad alta efficienza con alimentatore elettronico. Diffusore in polietilene opalino. Struttura in acciaio verniciato. Disponibile anche nella versione fluorescente da 55W + modulo RGB da 6W gestito da telecomando ad infrarossi.

Wall and ceiling high efficiency fluorescent lamp with electronic ballast. Polyethylene opalin diffuser, lacquered steel structure. Also available model with 55W fluorescent + 6W RGB LED module with infrared remote control.

Lampe fluorescente à haut rendement avec alimentateur électronique. Diffuseur en polyéthylène opal structure en acier verni. Fixation mur-plafond. Disponible également dans la version fluorescente de 55W + module RGB de 6W géré par télécommande à infrarouges.

Wand und Decke Leuchtstofflampe mit elektronisch Speisung. Diffusor aus opalem Polyethilen. Aufbau aus lackiertem Stahl. Erhältlich auch in der Leuchtstoffvariante mit 55W + RGB. Modul mit 6W und Infrarotfernsteuerung.

Lámpara fluorescente de pared y de techo de alta eficiencia con balasto. Difusor de polietileno opalino. Estructura de acero pintado. Disponible también en la versión fluorescente de 55W + módulo RGB de 6W que gestiona un mando a distancia de infrarrojos.

			521080.. 1 x 22W	
LENS 30	CODE 521080BI	DESCRIPTION 1 x 22W	NOTES  111580XX FC 22W 230V 2Gx13 T16	KG/LBS 1,9/4,2
			521070.. 1 x 55W	
LENS 40 LENS 40 RGB	CODE 521070BI 521100BI	DESCRIPTION 1 x 55W LENS 40 FLUO 1 x 55W LENS 40 FLUO + RGB	NOTES  111590XX FC 55W 230V 2Gx13 T16   111590XX FC 55W 230V 2Gx13 T16 LED RGB 6W 80 lm 	KG/LBS 3,25/7,2 3,78/8,3
	  	   IP20		





Corpo in metallo cromato.
Vetro satinato per luce uniforme ed intensa.

Metal Chromed frame with
sanded glass.

Corps en metal chromé
avec verre satiné.

Gehäuse aus metal verchromt mit
sandgestahltem glas.

Cuerpo en metal cromado. Cristal satinado
para luz uniforme e intensa.



MONOPARETEUNO	CODE 111090CR	DESCRIPTION 1 x 150W	NOTES 108210XX ALO HDG 150W 230V R7s 74.9 QT-DE 108210ES ALO HDG 120W 230V R7s 74.9 ES	KG/LBS 0,7/1,5
MONOPARETEDUE	CODE 111100CR	DESCRIPTION 1 x 250W	NOTES 112380ES ALO HDG 230W 230V R7s 114.2 ES	KG/LBS 1/2,2

**OMNIA MINI PARETE**

Lampada da parete, corpo in pressofusione di alluminio, in finitura cromata o verniciato grigio metallizzato. Diffusore in vetro al borosilicato sabbiato.

Wall lamp with die-casting aluminium body grey metallic painted or chromed. Diffuser in borosilicate sanded glass.

Lampe halogène à paroi en métal chromé ou gris métallisé, diffuseur en verre thermorésistant satiné.

Wandleuchte aus Metall, verchromt oder silber. Warmebeständiger satiniertes Glasschirm.

Lampara de pared en metal cromato y gris metalizado. Difusor de cristal termorresistente opaco.

OMNIA PARETE

Lampada alogena da parete in metallo, diffusore in vetro termoresistente satinato, serigrafato, bianco.







Metal halogen wall light, diffuser made of mat, screen-printed, white heat-resistant glass.

Lampe halogène à paroi en métal, diffuseur en verre, thermorésistant satiné, sérigraphié, blanc.

Halogen-Wandleuchte aus Metall, warmebeständiger satiniertes Glasschirm, mit Siebdruck, weiß.

Lampara halogena de pared en metal, difusor de cristal termoresistente opaco, serigrafado, blanco.



				
OMNIA MINI PARETE	CODE 108190CR 108440GM	DESCRIPTION 1 x 200W	NOTES  108270XX ALO HDG 200W 230V R7s-114.2 QT-DE 108270ES ALO HDG 160W 230V R7s-114.2 ES	KG/LBS 0,52/1,2
				
OMNIA PARETE	CODE 106490CR 106820GM 106470CR 106790GM 106480CR 106810GM	DESCRIPTION 1 x 250W vetro serigrafato screen-printed glass 1 x 250W vetro bianco white glass 1 x 250W vetro satinato matt glass	NOTES  112380ES ALO HDG 230W 230V R7s-114.2 ES	KG/LBS 0,75/1,17
 		   		

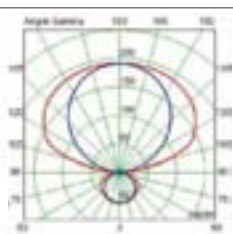
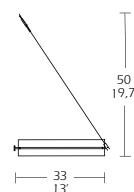
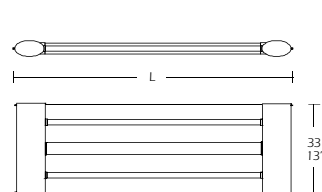

527030.. 2 x 54W
+ 527090BI

OMNIA ECO PARETE	CODE	DESCRIPTION	NOTES	KG/LBS
	527010GM	L = 75/29,5' 2 x 24W	109060XX FL FQ 24W 230V G5 T16	2/4,4
	527020GM	L = 105/41,3' 2 x 39W	109070XX FL FQ 39W 230V G5 T16	2,8/6,2
	527030GM	L = 135/53,1' 2 x 54W	109080XX FL FQ 54W 230V G5 T16	3,6/7,9
	108620GM	kit parete plafone kit for wall/fixture		0,41/0,9
	108630GM	kit per ponte lato corto kit for bridge short side		
	108640GM	kit per ponte lato lungo kit for bridge long side		

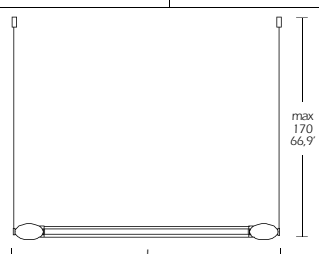
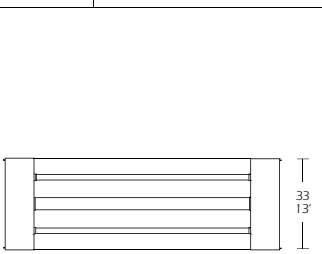

OMNIA ECO SOSPENSIONE	CODE	DESCRIPTION	NOTES	KG/LBS
	527010GM	L = 75/29,5' 2 x 24W	109060XX FL FQ 24W 230V G5 T16	2/4,4
	527020GM	L = 105/41,3' 2 x 39W	109070XX FL FQ 39W 230V G5 T16	2,8/6,2
	527030GM	L = 135/53,1' 2 x 54W	109080XX FL FQ 54W 230V G5 T16	3,6/7,9
	108730GM	kit per sospensione suspension kit		0,5/1,1

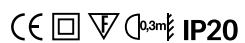

Diffusori ed ottiche
Diffuseurs and optics

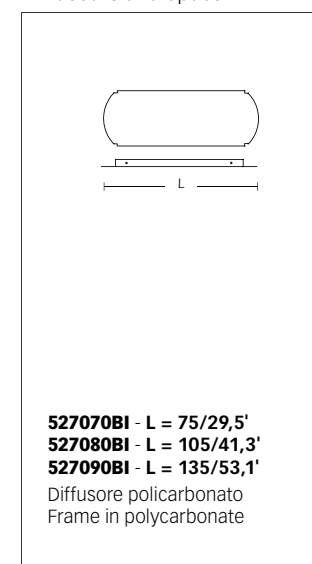

Lampada parete/soffitto, disponibile scegliendo l'apposito kit per montaggio a parete, plafone, nonché a parete a sbalzo con inclinazione regolabile, sia sul lato corto che sul lato lungo. Corpo in policarbonato e in estruso di alluminio verniciati. Diffusore in policarbonato serigrafato, micro Dark Light e frangiluce in lamiera d'alluminio microforata.

Wall/ceiling lamp, available choosing the special wall-mounting kit, fixture as well as wall projected with adjustable inclination, both on short side and on long side. Frame in polycarbonate or extruded aluminium, painted. Silk-screened polycarbonate diffuser, Dark Light micro diffuser and micro holed aluminium light breaker.

Applique/plafonnier, disponible en choisissant le kit approprié pour le montage mural, plafond, ainsi que mural en porte-à-faux avec inclinaison réglable, tant sur le côté court que sur le côté long. Corps en polycarbonate et en aluminium extrudé, peints. Diffuseur en polycarbonate sérigraphié, micro-réflecteur lumière noire et brise-lumière en tôle d'aluminium microperforée.

Wand-/Deckenleuchte, erhältlich als Bausatz für Wandmontage, Decken-sowie Wandleuchte, vorstehend, sowohl quer wie längs einstellbarer Neigung. Gehäuse aus Polycarbonat und fließgepresstem Aluminium, lackiert. Diffusor aus serigraphiertem Polycarbonat, Mikro-Dark Light und Blendschutzraster aus mikroperforiertem Aluminiumblech.

Lampara de pared/techo, disponible eligiendo el kit de montaje a pared al efecto, plafón así como a pared repujado con inclinación regulable, sea en el lado corto sea en el lado largo. Cuerpo en policarbonato y extruido de aluminio barnizados. Difusor de policarbonato serigrafado, micro "Dark Light" y pantalla antideslumbrante de chapa de aluminio microperforada.

Lampada da parete ad alogenuri metallici.
Corpo in policarbonato verniciato grigio metallizzato.

Metal Halide wall lamp.
Frame in polycarbonate grey metallic painted.

Applique à décharge.
Corps en polycarbonate verni gris métallisé.

Wandstrahler für Halogenmetalllampen.
Gehäuse aus polycarbonat metallic grau lackiert.

Lámpara de pared de halogenuro metálico.
Cuerpo de policarbonato pintado de gris metalizado.



Lampada da parete ad alogenuri metallici.
Corpo in policarbonato verniciato grigio metallizzato.
Tubo in ottone cromato.
Disponibile nella versione a due vetri sabbati e ad un vetro più riflettore.

Metal Halide wall lamp.
Frame in polycarbonate grey metallic painted. Chromium-plated brass tube.
Available in version with two sanded glasses and with one glass plus reflector.

Applique à décharge. Corps en polycarbonate verni gris métallisé, tube de laiton chromé. Disponible dans la version à deux verres dépolis et à un verre plus réflecteur.

Wandstrahler für Halogenmetalllampen.
Gehäuse aus polycarbonat silber lackiert. Rahmen aus verchromtem Messing. Erhältlich entweder mit zwei sandgestrahlten Glasscheiben, oder mit einem Glas und einem Reflektor.

Lámpara de pared de halogenuro metálico. Cuerpo de policarbonato pintado de gris metalizado. Tubo en latón cromado. Disponible en la versión de dos cristales satinados y un cristal + reflector.



			110720.. 1 x 70W						
OMNIA E27 PARETE HQI	CODE	DESCRIPTION	NOTES	KG/LBS					
	110720GM	1 x 70W	110970XX A.M. MRS 70W 230V E27 PAR30	1,21/2,7					
									IP40

			110700.. 1 x 70W	110710.. 1 x 70W				
OMNIA EGG PARETE HQI	CODE	DESCRIPTION	NOTES	KG/LBS				
	110700GM	1 x 70W 2 vetri sabbati 2 sanded glasses	110960XX A.M. MT 70W 230V G8.5	1,8/4				
	110710GM	1 x 70W vetro sabbato + riflettore 1 sanded glass + reflector		1,57/3,5				
								IP20

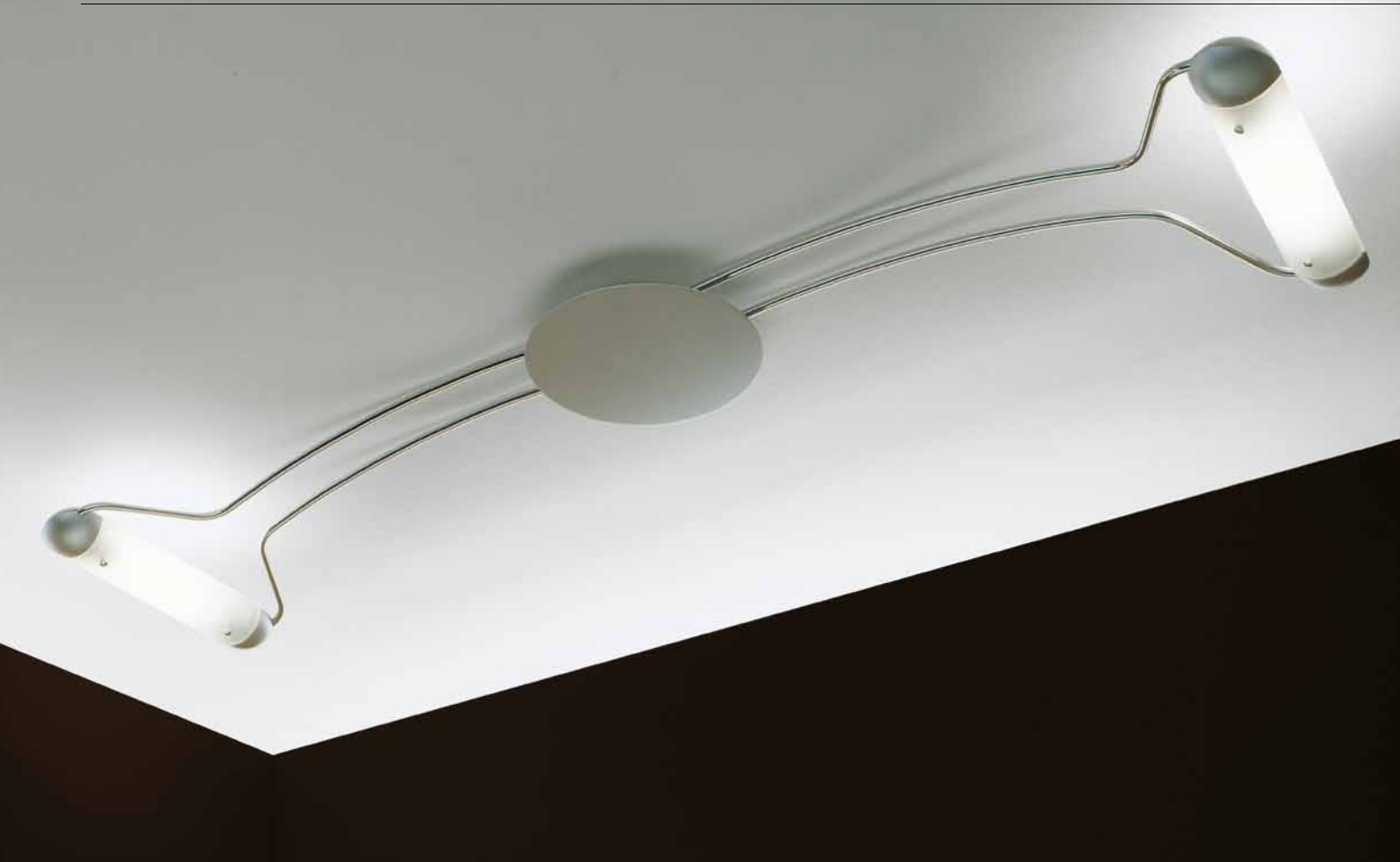
**OMNIA GLASS PARETE CORTA**

Apparecchio di illuminazione a parete.
Corpo stampato in tecnopolimeri verniciato
grigio alluminio. Bracci in ottone cromato.
Lampadina alogena lineare R7s 250W.

Wall lighting fixture. Moulded technopolymer
frame with a lacquered aluminium finish.
Takes one R7s 250W linear halogen bulb.

Appareillage d'éclairage mural. Corps moulé
en technopolymères peint gris aluminium.
Bras en laiton chromé.
Ampoule halogène linéaire R7s 250W.

Gegossenes Technopolymer-Gehäuse,
aluminiumgrau lackiert. Verchromte
Messingarme.
Lineare Halogenglühlampe R7s 250W.

Aparato de iluminacion de pared. Estructura
moldeada en tecnopolimeros barnizada gris
aluminio. Brazos en latón cromado.
Bombilla halogena lineal R7s 250W.

OMNIA GLASS SOFFITTO

Apparecchio di illuminazione a soffitto.
Corpo stampato in tecnopolimeri verniciato
grigio alluminio. Bracci in ottone cromato.
Lampadina alogena lineare R7s 250W.

Ceiling light appliance. Moulded
technopolymer frame with a lacquered
aluminium finish.
Takes one R7s 250W linear halogen bulb.

Appareillage d'éclairage fixé au plafond.
Corps moulé en technopolymères peint gris
aluminium. Bras en laiton chromé.
Ampoule halogène linéaire R7s 250W.

Deckenleuchte. Gegossenes
Technopolymer-Gehäuse, aluminiumgrau
lackiert. Verchromte Messingarme.
Lineare Halogenglühlampe R7s 250W.

Aparato de iluminacion de techo. Estructura
moldeada en tecnopolimeros barnizada gris
aluminio. Brazos en latón cromado.
Bombilla halogena lineal R7s 250W.

OMNIA GLASS PARETE CORTA	CODE 107500GM	DESCRIPTION 1 x 250W	NOTES 112380ES ALO HDG 230W 230V R7s-114.2 ES	KG/LBS 1,1/2,4
OMNIA GLASS SOFFITTO	CODE 107520GM	DESCRIPTION 2 x 250W	NOTES 112380ES ALO HDG 230W 230V R7s-114.2 ES	KG/LBS 2,48/5,5



Faretto orientabile con tige per lampadina alogena e ad incandescenza. Riflettore in policarbonato disponibile in 6 differenti colori o in alluminio anodizzato.

Adjustable spot with stem for halogen and incandescent bulb. Polycarbonate reflector available in 6 different colours or in anodized aluminium.

Spot orientable avec tige pour ampoule halogène et incandescence. Réflecteur en polycarbonate disponible en 6 coloris ou en aluminium anodisé.

Verstellbarer Strahler mit Ständer für Halogen- und Glühlampe. Polykarbonat-Reflektor aus Eloxal oder in 6 verschiedenen Farben erhältlich.

Foco orientable con tige para bombilla halógena y de incandescencia. Reflector en policarbonato disponible en 6 diferentes colores o en aluminio anodizado.



OMNIA SPOT E27	<table border="1"> <thead> <tr> <th>CODE</th> <th>DESCRIPTION</th> <th>NOTES</th> <th>KG/LBS</th> </tr> </thead> <tbody> <tr> <td>106320BI 106320BL 106320GI 106320GM 106320RO 106320VE</td> <td>1 x 100W corpo grigio metallizzato riflettore policarbonato grey metallic frame polycarbonate reflector</td> <td rowspan="2"> 108220XX ALO HAGS 100W 230V E27 PAR30 </td> <td rowspan="2"> 0,31/0,7 </td> </tr> <tr> <td>106320AL</td> <td>1 x 100W corpo grigio metallizzato riflettore alluminio anodizzato grey metallic frame anodized aluminium reflector</td> </tr> </tbody> </table>	CODE	DESCRIPTION	NOTES	KG/LBS	106320BI 106320BL 106320GI 106320GM 106320RO 106320VE	1 x 100W corpo grigio metallizzato riflettore policarbonato grey metallic frame polycarbonate reflector	 108220XX ALO HAGS 100W 230V E27 PAR30	0,31/0,7	106320AL	1 x 100W corpo grigio metallizzato riflettore alluminio anodizzato grey metallic frame anodized aluminium reflector
CODE	DESCRIPTION	NOTES	KG/LBS								
106320BI 106320BL 106320GI 106320GM 106320RO 106320VE	1 x 100W corpo grigio metallizzato riflettore policarbonato grey metallic frame polycarbonate reflector	 108220XX ALO HAGS 100W 230V E27 PAR30	0,31/0,7								
106320AL	1 x 100W corpo grigio metallizzato riflettore alluminio anodizzato grey metallic frame anodized aluminium reflector										
AL BI BL GI GM RO VE											

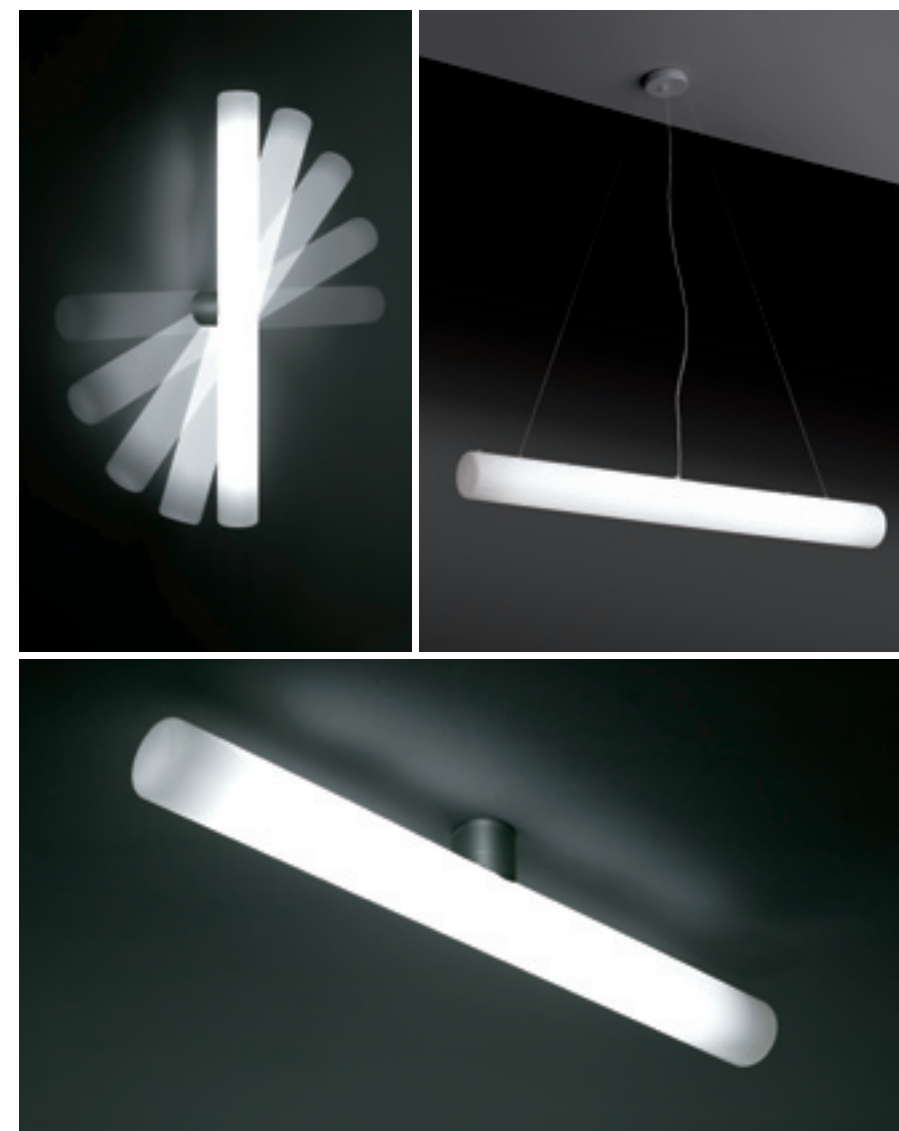

Lampada fluorescente rotante da parete e soffitto. Diffusore in polietilene opalino. Base in policarbonato, struttura in acciaio. Colori base e struttura grigio metallizzato. Potenza 2x54W. Disponibile anche con intensità luminosa regolabile.

Rotating wall or ceiling mounting fluorescent lamp. Opal polyethylene diffuser. Polycarbonate bases, steel structure. Base and structure available in metallised grey. Power 2x54W. Also available with dimmer.

Lampe fluorescente pivotante pour fixation mur-plafond. Diffuseur en polyéthylène opalin. Socles en polycarbonate, structure en acier. Couleurs du socle et de la structure gris métallisé. Puissance 2x54W. Egalement disponible avec une intensité lumineuse réglable.

Drehbare Leuchtstoffleuchte für die Wand- und Deckenmontage. Diffusor aus opalem Polyethylen. Leuchtensockel aus Polycarbonat, Struktur aus Stahl. Leuchtensockel und Struktur silber. Leistung 2x54W. Auch mit Dimmer erhältlich.

Lámpara fluorescente giratoria de pared o de techo. Difusor de polietileno opal. Bases de policarbonato, estructura de acero. Colores de base y estructura gris metalizado. Potencia 2x54W. Disponible también con intensidad luminosa regulable.

			<p>521030... 521110... 2 x 54W 521120...</p>			
	CODE	DESCRIPTION			NOTES	KG/LBS
	521110GM	2 x 54W/28W			109080XX FL FQ 54W 230V G5 T16 110980XX FL FH 28W 230V G5 T16	3,98/8,6
	521030GM	2 x 54W/28W				3,93/8,7
	521120GM	2 x 54W/28W		3,7/8,2		
	CODE	DESCRIPTION			NOTES	KG/LBS
	521050GM	2 x 54W/28W			109080XX FL FQ 54W 230V G5 T16 110980XX FL FH 28W 230V G5 T16	4/8,8
	521060GM	2 x 54W/28W				
	521130GM	2 x 54W/28W				

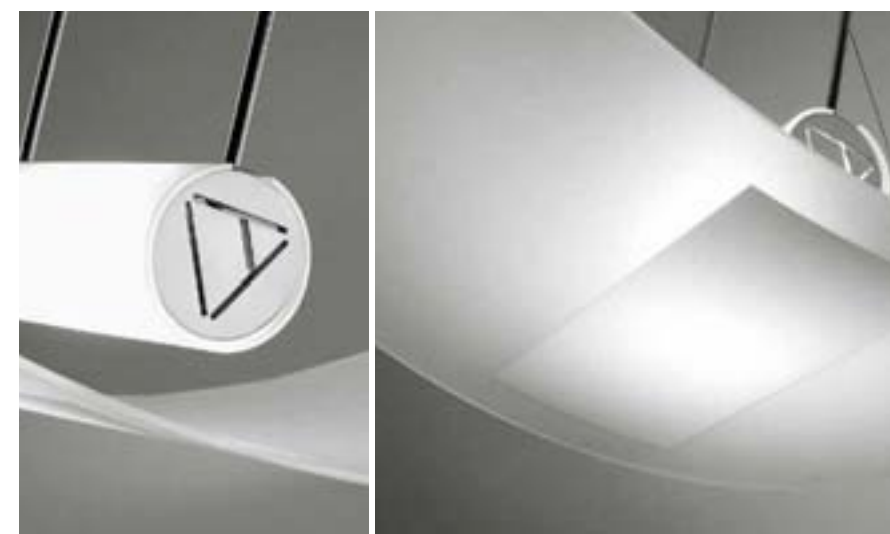







Lampada da sospensione, regolabile in altezza. Corpo cromato, vetro cilindrico satinato e vetro diffusore curvato e serigrafato.

Hanging lamp, height adjustable. Chromium-plated frame, cylindrical satin glass and curved and screen-printed diffuser glass.

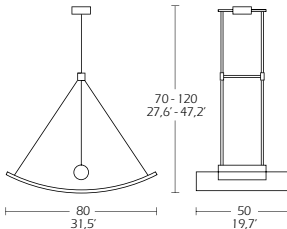
Suspension réglable en hauteur. Corps chromé, verre cylindrique satiné et verre diffuseur bombé, avec sérigraphie.

Hängeleuchte, höhenverstellbar. Verchromtes Gehäuse, zylinderförmiges, satiniertes Glas und gebogenes Diffusorglas, serigraphiert.

Lampara de suspensión regulable en altura. Cuerpo cromado, cristal cilíndrico satinado y cristal pantalla curvado y serigrafado.

			NOTES  108790XX ALO HDG 300W 230V R7s-114.2 QT-DE 112380ES ALO HDG 230W 230V R7s-114.2 ES	KG/LBS 5,9/13
	SUN	CODE 108570CR		
				   IP20



Lampada da parete e soffitto fluorescente ad alta efficienza con alimentatore elettronico.
Diffusore in polietilene opalino.
Struttura in acciaio verniciato.

Wall and ceiling high efficiency fluorescent lamp with electronic ballast. Polyethylene opalin diffuser, lacquered steel structure.

Lampe fluorescente à haut rendement avec alimentateur électronique. Diffuseur en polyéthylène opal structure en acier verni. Fixation mur-plafond.

Wand und Decke Leuchtstofflampe mit elektronisch Speisung.
Diffusor aus opalem Polyethilen.
Aufbau aus lackiertem Stahl.

Lámpara fluorescente de pared y techo que ofrece alto rendimiento con alimentador electrónico.
Difusor en polietileno opal.
Estructura en acero barnizado.

XSQUARE PARETE/SOFFITTO	CODE	DESCRIPTION	NOTES	KG/LBS
	521090BI	2 x 8W		1,25/2,8
BI	ES	EL	750°	





Elementi modulari con corpo in policarbonato estruso semi trasparente ed attacchi cromati per lampade fluorescenti alimentate elettronicamente. I singoli elementi formano un sistema completo e versatile, adatto a risolvere tutte le complesse problematiche di illuminazione che spazi pubblici o ambienti di lavoro ormai impongono.

Modular elements with frame in polycarbonate extruded semi-transparent and chromed holders for fluorescent bulbs. Feature electronic supply control. The modular elements can be combined together, offering a flexible and comprehensive system capable of solving all the complex lighting requirements that public and working spaces oblige to satisfy.

Eléments modulaires avec un corps en polycarbonate extrudé semi-transparent et des culots chromés pour lampes fluorescentes à alimentation électronique.

Les éléments individuels forment un système complet et polyvalent, à même de résoudre tous les problèmes complexes d'éclairage désormais posés par les lieux publics ou de travail.

Modulierte Elemente mit Polikarbonat Körper, Drahteisen semi-transparent und verchromten Verbindungen für Leuchtstofflampen mit elektronische Speisung.

Die einzeln Elementen stellen ein komplett und beweglich System auf, gültig alle die komplizierte Beleuchtung Probleme aufzulösen.

Elementos modulares con cuerpo de policarbonato extruido semitransparente y enganches cromados para lámparas fluorescentes con alimentación electrónica. Cada uno de los elementos forma un sistema completo y versátil, indicado para resolver los complejos problemas de iluminación que presentan los espacios públicos o entornos de trabajo en la actualidad.

Versione con alimentatore elettronico integrato
 Integrated electronic ballast version
 Version avec ballast électronique intégré
 Integriert elektronisch Speisung version
 Versión con alimentador electrónico integrado

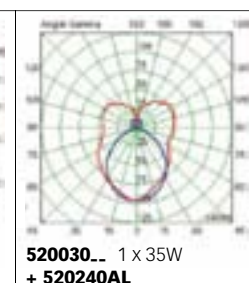
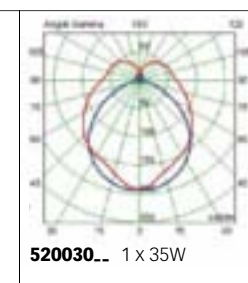
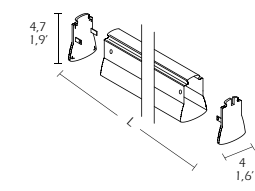

MANDARIN	CODE	DESCRIPTION	NOTES	KG/LBS
	520010BI	L = 96/37,7' 1 x 21W	110390XX FL FH 21W 230V G5 T16	0,71/1,6
	520020BI	L = 126/49,6' 1 x 28W	110980XX FL FH 28W 230V G5 T16	0,94/2,1
	520030BI	L = 156/61,4' 1 x 35W	110950XX FL FH 35W 230V G5 T16	1,16/2,6

BI
ES
EL
750'
CE
IP20

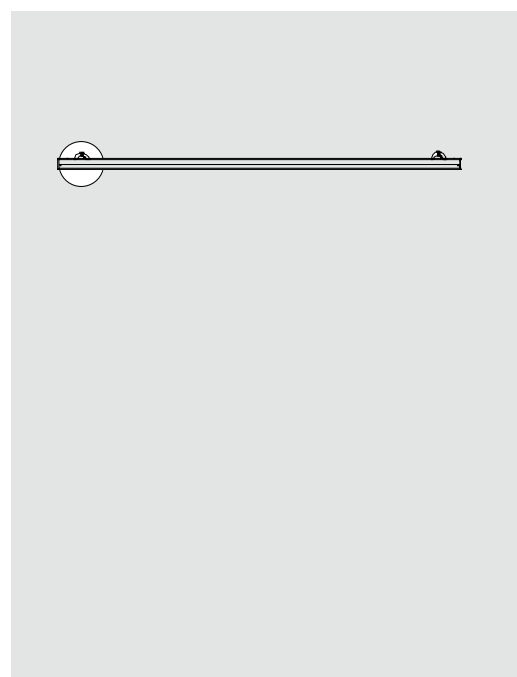

FISSAGGIO A PARETE
WALL FIXING SUPPORT
FIXATION MURALE
WAND FIXIERUNG
FIJACIÓN DE PARED

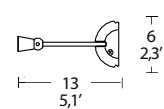

520070CR
 Supporto fissaggio a parete
 Wall fixing support

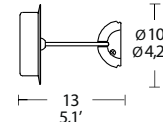

520100CR
 Supporto alimentazione a parete
 Wall supply support
520330XX
 Cavo di alimentazione da ordinare separatamente
 Power cord to be ordered separately

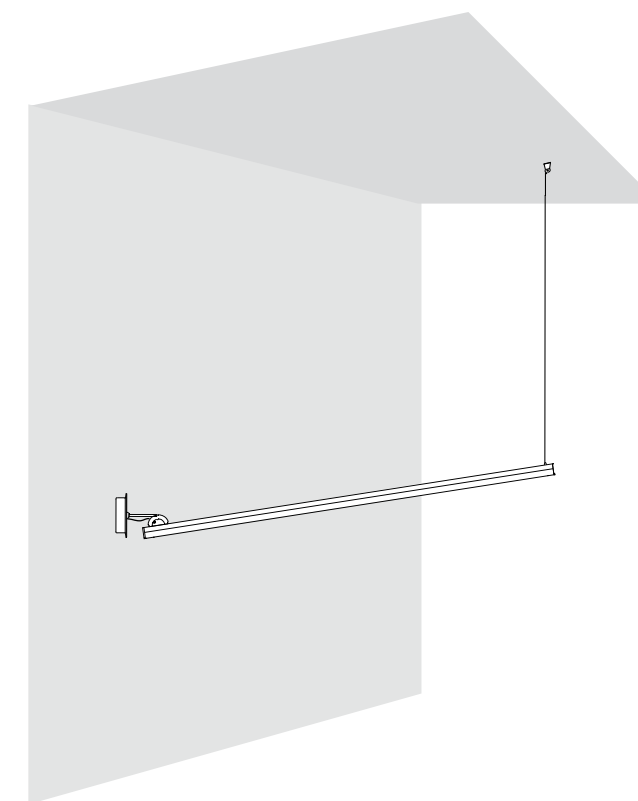
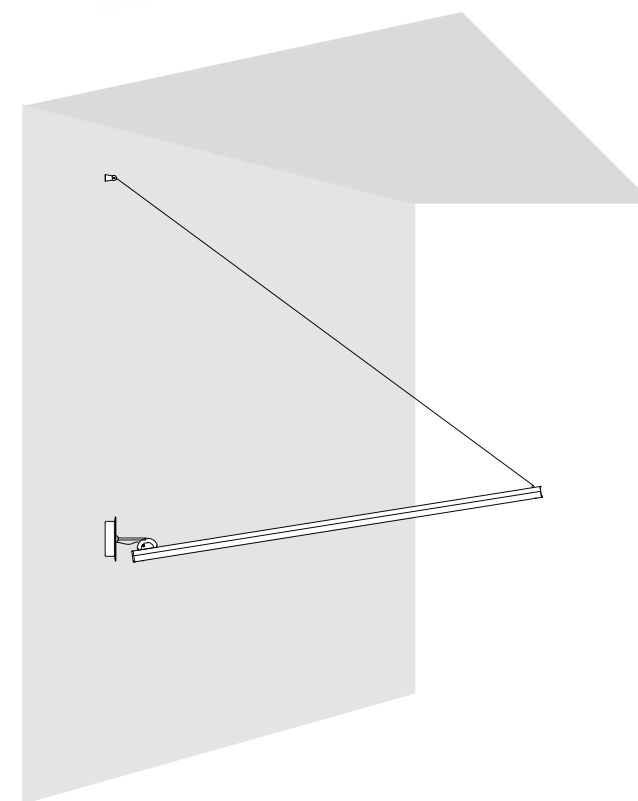

FISSAGGIO A SBALZO
OVER-HANGING FIXING
FIXATION AVEC BRAS
AUSSEN-HÄNGENDE BEFESTIGUNG
FIJACIÓN EN VOLADIZO

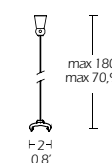

520080CR
 Supporto fissaggio parete sbalzo
 Over-hanging fixing support

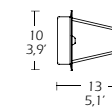

520110CR
 Supporto alimentazione parete sbalzo
 Over-hanging supply support
520330XX
 Cavo di alimentazione da ordinare separatamente
 Power cord to be ordered separately



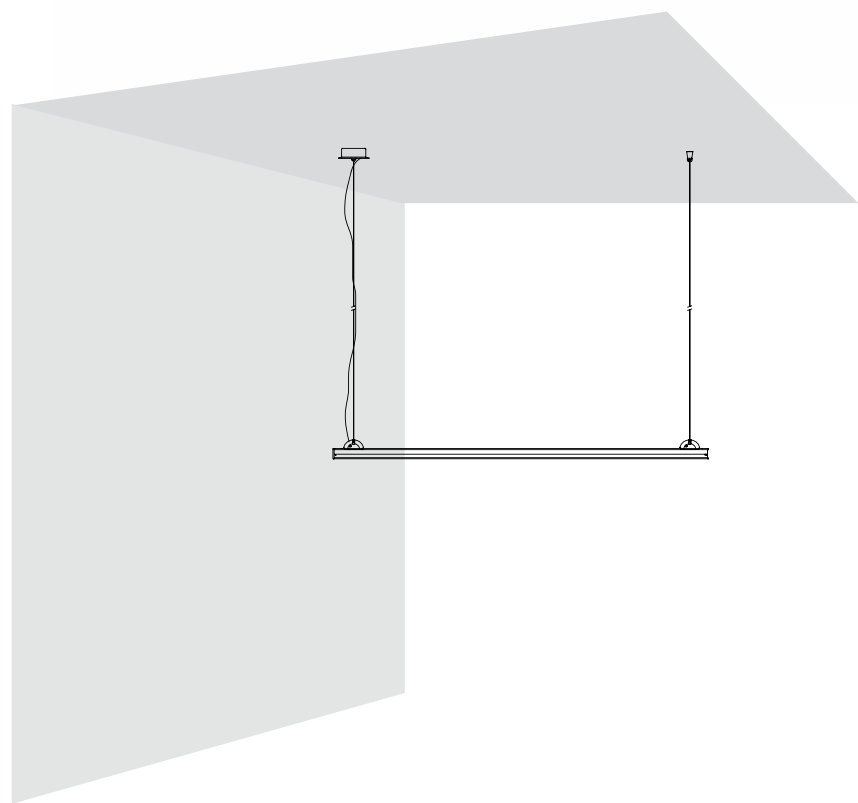

FISSAGGIO SOSPENSIONE
HANGING FIXING
FIXATION EN SUSPENSION
AUFHÄNGUNG FIXIERUNG
FIJACIÓN EN SUSPENSIÓN

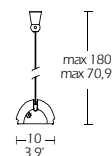

520090CR
 Supporto fissaggio sospensione
 Hanging fixing supply

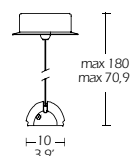

520120CR
 Supporto alimentazione sospensione
 Hanging power supply

520330XX
 Cavo di alimentazione da ordinare separatamente
 Power cord to be ordered separately



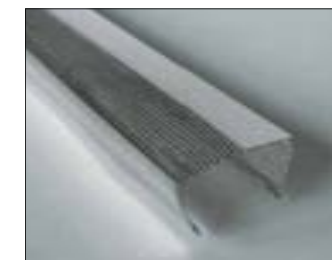
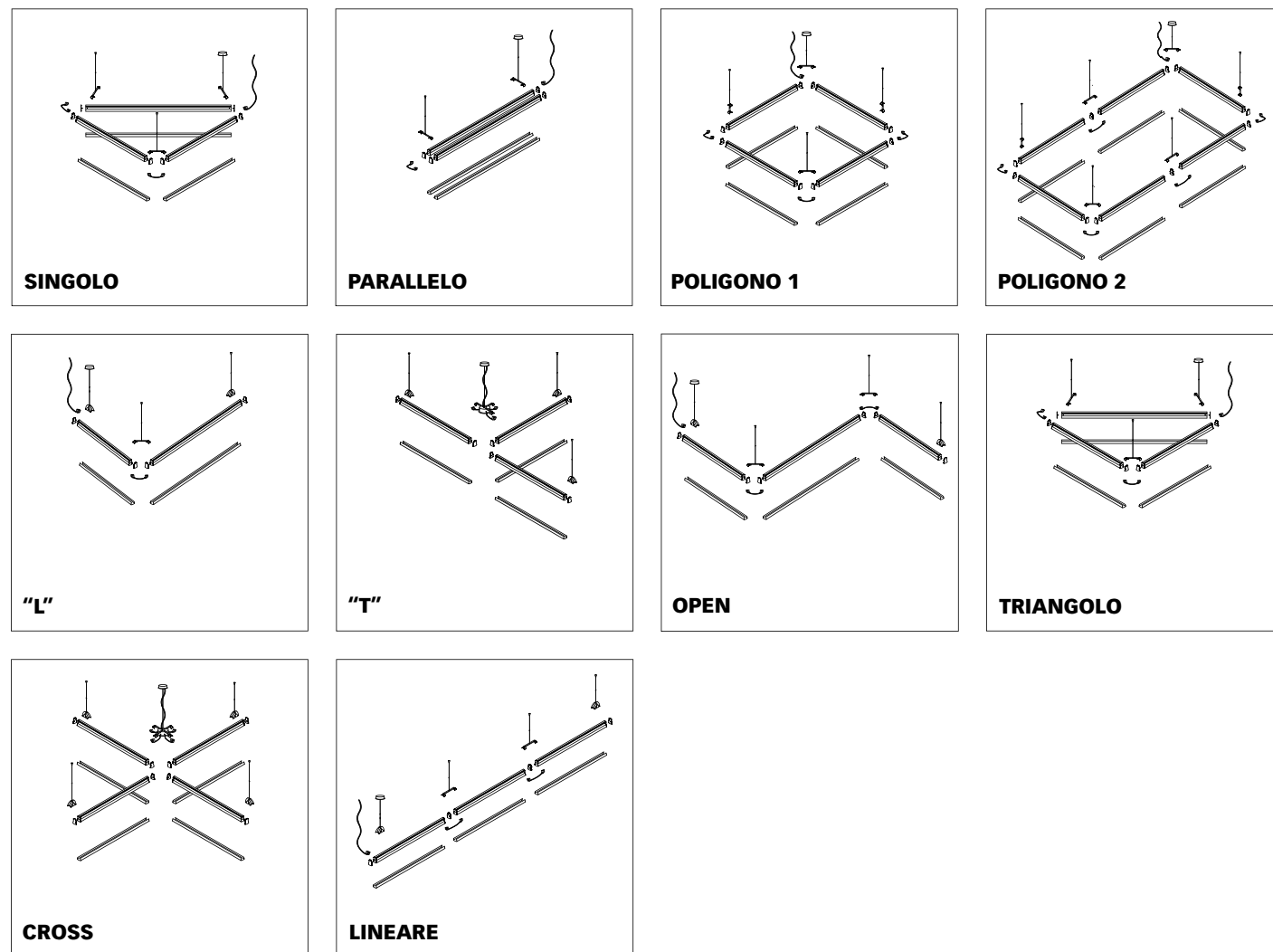

FRANGILUCE MICROFORATO
520220AL - L = 96/37,8'
520230AL - L = 126/49,6'
520240AL - L = 156/61,4'
 Frangiluce in alluminio microforato
 Micro holed aluminium
 light breaker

AL



GIUNTO LINEARE
520290XX
 Giunto lineare/Linear junction

XX

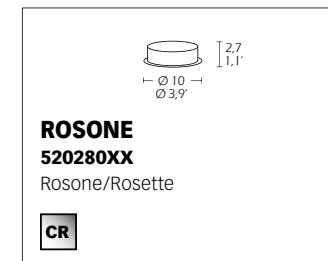

ROSONE
520280XX
 Rosone/Rosette

CR

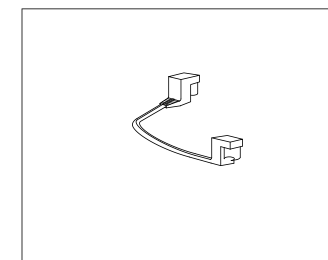

CAVO ACCOPIAMENTO
520310XX - L = 15/5,9'
 Cavo accoppiamento elettrico
 Bus wire

XX

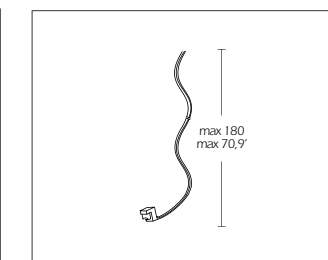

CAVO ALIMENTAZIONE
520330XX
 Cavo alimentazione standard bianco
 Standard power cord

XX

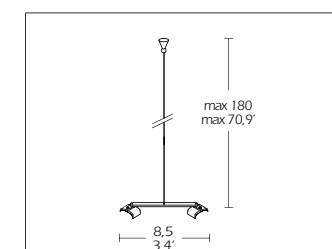

SUPPORTO 360°
520300CR
 Supporto sospensione 360°
 360° hanging supply support

CR

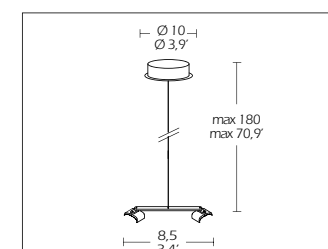

SUPPORTO ALIMENTAZIONE 360°
520320CR
 Supporto alim. sospensione 360°
 360° hanging power supply support
520330XX
 Cavo di alimentazione
 da ordinare separatamente
 Power cord to be ordered separately

CR

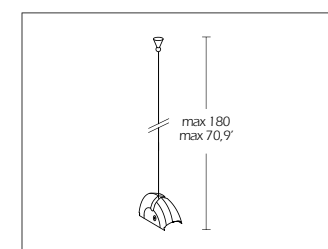

SUPPORTO SOSPENSIONE
520090CR
 Supporto sospensione
 Hanging supply

CR

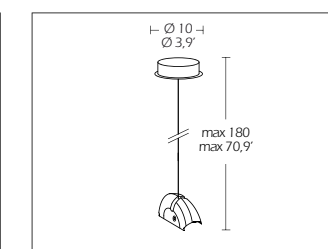

SUPPORTO ALIMENTAZIONE SOSPENSIONE
520120CR
 Supporto alimentazione sospensione
 Hanging power supply
520330XX
 Cavo di alimentazione
 da ordinare separatamente
 Power cord to be ordered separately

CR

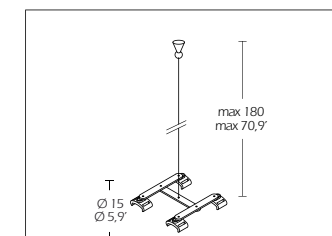

SUPPORTO PARALLELO
520350CR
 Supporto parallelo
 Parallel support

CR

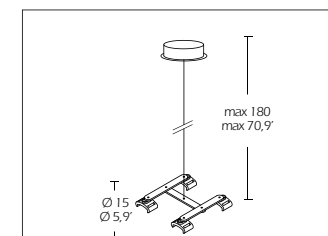

SUPPORTO ALIMENTAZIONE PARALLELO
520340CR
 Supporto alimentazione parallelo
 Parallel supply-support
520330XX
 Cavo di alimentazione
 da ordinare separatamente
 Power cord to be ordered separately

CR

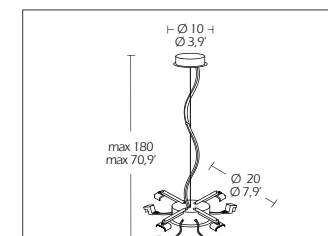

GIUNTO A CROCE
520260XX
 Giunto a croce
 Cavo di alimentazione incluso
 Cross joint
 Power cord included

CR

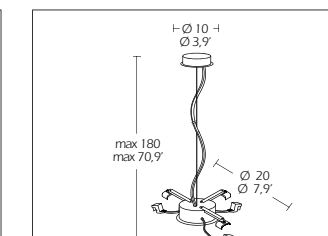









GIUNTO "T"
520270XX
 Giunto "T"
 Cavo di alimentazione incluso
 "T" joint
 Power cord included

CR



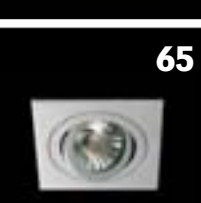

- COMPASSO 2** 62 
- COMPASSO 3** 62 
- G16** 64 
- M16** 64 
- G11** 65 
- M11** 65 
- M16Q** 65 
- M11Q** 65 
- MINI BASKET 12V** 66 

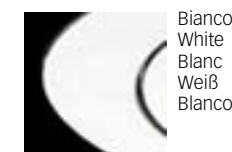

Bianco
White
Blanc
Weiß
Blanco

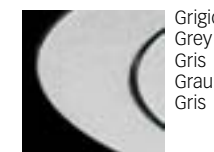

Grigio
Grey
Gris
Grau
Gris

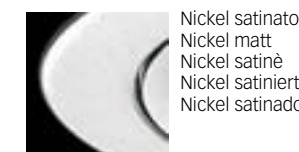

Nickel satinato
Nickel matt
Nickel satiné
Nickel satiniert
Nickel satinado



Utilizza una nuova lampadina dicroica ad alto rendimento, lunga durata e forte intensità luminosa.

It use a new mini dichroic halogen bulb with high efficiency, long lenth and bright lighting intensity.

Il utilise une nouvelle mini ampoule dichroïque avec haut rendement, longue durée et forte intensité lumineuse.

Entwickelt fuer eine neue mini Halogen Kaltlichtspiegellampe mit hoher effizient, langer Lebensdauer und Starker Lichtintensitaet.

Utiliza una nueva mini bombilla dicroica con alto rendimiento, larga duracion y fuerte intensidad luminosa.









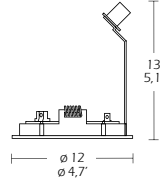

Faretto ad incasso girevole e orientabile in pressofusione d'alluminio, disponibile nei colori bianco, grigio o nickel satinato. Utilizza una nuova lampadina dicroica ad alto rendimento, lunga durata e forte intensità luminosa. Possibilità di sensore per accensione automatica. Trasformatore non incluso.

Recessed fully adjustable spotlight made of die-cast aluminium, available in white, grey or nickel matt finish. It use a new mini dichroic halogen bulb with high efficiency, long lenth and bright lighting intensity. Sensor possibility for automatic lighting. Transformer not included.

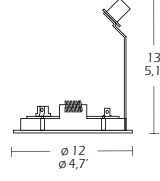





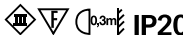



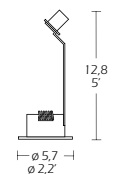







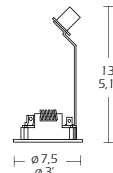

Spot a encastrer tournant et orientable en aluminium, disponible en blanc, gris ou nickel satiné. Il utilise une nouvelle mini ampoule dichroïque avec haut rendement, longue durée et forte intensité lumineuse. Possibilité d'un capteur pour allumage automatique. Transformateur pas inclus.









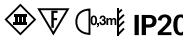

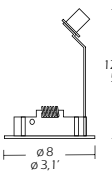







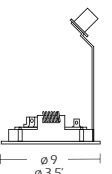

Einbaustrahler drehbar und schwenkbar, aus Fliessgepresstem Aluminium. In der Farben weiss, grau, Nickel satiniert. Entwickelt fuer eine neue mini Halogen Kaltlichtspiegellampe mit hoher effizient, langer Lebensdauer und Starker Lichtintensitaet. Die Verwendung eines Lichtsensor ist moeglich. Transformator nicht beigelect.









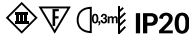

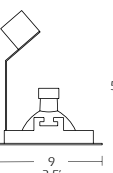













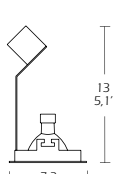

Spot a emprotar girable y orientable en aluminium, disponible en blanco, gris o nickel satinado. Utiliza una nueva mini bombilla dicroica con alto rendimiento, larga duracion y fuerte intensidad luminosa. Posibilidad de sensore por abrazamiento automatico. Transformador non incluso.

									
<p>COMPASSO 2</p>	<table border="1"> <thead> <tr> <th>CODE</th> <th>DESCRIPTION</th> <th>NOTES</th> <th>KG/LBS</th> </tr> </thead> <tbody> <tr> <td>505310BI 505320GM 505330NS</td> <td>2 x 35W</td> <td> 109940XX ALO HRGS 35W 12V GZ4 MR8 24°</td> <td>0,2/0,4</td> </tr> </tbody> </table>	CODE	DESCRIPTION	NOTES	KG/LBS	505310BI 505320GM 505330NS	2 x 35W	 109940XX ALO HRGS 35W 12V GZ4 MR8 24°	0,2/0,4
CODE	DESCRIPTION	NOTES	KG/LBS						
505310BI 505320GM 505330NS	2 x 35W	 109940XX ALO HRGS 35W 12V GZ4 MR8 24°	0,2/0,4						
									
<p>COMPASSO 3</p>	<table border="1"> <thead> <tr> <th>CODE</th> <th>DESCRIPTION</th> <th>NOTES</th> <th>KG/LBS</th> </tr> </thead> <tbody> <tr> <td>505410BI 505420GM 505430NS</td> <td>3 x 20W</td> <td> 109930XX ALO HRGS 20W 12V GZ4 MR8 21° 112420XX ALO HRGS 20W 12V GZ4 MR8 10°</td> <td>0,24/0,5</td> </tr> </tbody> </table>	CODE	DESCRIPTION	NOTES	KG/LBS	505410BI 505420GM 505430NS	3 x 20W	 109930XX ALO HRGS 20W 12V GZ4 MR8 21° 112420XX ALO HRGS 20W 12V GZ4 MR8 10°	0,24/0,5
CODE	DESCRIPTION	NOTES	KG/LBS						
505410BI 505420GM 505430NS	3 x 20W	 109930XX ALO HRGS 20W 12V GZ4 MR8 21° 112420XX ALO HRGS 20W 12V GZ4 MR8 10°	0,24/0,5						
<p>BI GM NS    </p>									



									
G11	<table border="1"> <thead> <tr> <th>CODE</th> <th>DESCRIPTION</th> <th>NOTES</th> <th>KG/LBS</th> </tr> </thead> <tbody> <tr> <td>508510BI 508520GM 508530NS</td> <td>1 x 35W</td> <td>  110370XX ALO HRGS 35W 12V GZ4 MR11</td> <td>0,10/0,2</td> </tr> </tbody> </table>	CODE	DESCRIPTION	NOTES	KG/LBS	508510BI 508520GM 508530NS	1 x 35W	  110370XX ALO HRGS 35W 12V GZ4 MR11	0,10/0,2
CODE	DESCRIPTION	NOTES	KG/LBS						
508510BI 508520GM 508530NS	1 x 35W	  110370XX ALO HRGS 35W 12V GZ4 MR11	0,10/0,2						
									
M11	<table border="1"> <thead> <tr> <th>CODE</th> <th>DESCRIPTION</th> <th>NOTES</th> <th>KG/LBS</th> </tr> </thead> <tbody> <tr> <td>508710BI 508720GM 508730NS</td> <td>1 x 35W</td> <td>    110370XX ALO HRGS 35W 12V GZ4 MR11</td> <td>0,12/0,3</td> </tr> </tbody> </table>	CODE	DESCRIPTION	NOTES	KG/LBS	508710BI 508720GM 508730NS	1 x 35W	    110370XX ALO HRGS 35W 12V GZ4 MR11	0,12/0,3
CODE	DESCRIPTION	NOTES	KG/LBS						
508710BI 508720GM 508730NS	1 x 35W	    110370XX ALO HRGS 35W 12V GZ4 MR11	0,12/0,3						
<p>BI GM NS </p>									

									
G16	<table border="1"> <thead> <tr> <th>CODE</th> <th>DESCRIPTION</th> <th>NOTES</th> <th>KG/LBS</th> </tr> </thead> <tbody> <tr> <td>508610BI 508620GM 508630NS</td> <td>1 x 50W</td> <td>  108770XX ALO HRGS 50W 12V GU5.3 QR-CB</td> <td>0,11/0,2</td> </tr> </tbody> </table>	CODE	DESCRIPTION	NOTES	KG/LBS	508610BI 508620GM 508630NS	1 x 50W	  108770XX ALO HRGS 50W 12V GU5.3 QR-CB	0,11/0,2
CODE	DESCRIPTION	NOTES	KG/LBS						
508610BI 508620GM 508630NS	1 x 50W	  108770XX ALO HRGS 50W 12V GU5.3 QR-CB	0,11/0,2						
									
M16	<table border="1"> <thead> <tr> <th>CODE</th> <th>DESCRIPTION</th> <th>NOTES</th> <th>KG/LBS</th> </tr> </thead> <tbody> <tr> <td>508810BI 508820GM 508830NS</td> <td>1 x 50W</td> <td>    108770XX ALO HRGS 50W 12V GU5.3 QR-CB</td> <td>0,15/0,3</td> </tr> </tbody> </table>	CODE	DESCRIPTION	NOTES	KG/LBS	508810BI 508820GM 508830NS	1 x 50W	    108770XX ALO HRGS 50W 12V GU5.3 QR-CB	0,15/0,3
CODE	DESCRIPTION	NOTES	KG/LBS						
508810BI 508820GM 508830NS	1 x 50W	    108770XX ALO HRGS 50W 12V GU5.3 QR-CB	0,15/0,3						
<p>BI GM NS </p>									

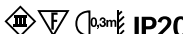
									
M16Q	<table border="1"> <thead> <tr> <th>CODE</th> <th>DESCRIPTION</th> <th>NOTES</th> <th>KG/LBS</th> </tr> </thead> <tbody> <tr> <td>513911BI 513975GM 513934NS</td> <td>1 x 50W</td> <td>    108770XX ALO HRGS 50W 12V GU5.3 QR-CB</td> <td>0,16/0,4</td> </tr> </tbody> </table>	CODE	DESCRIPTION	NOTES	KG/LBS	513911BI 513975GM 513934NS	1 x 50W	    108770XX ALO HRGS 50W 12V GU5.3 QR-CB	0,16/0,4
CODE	DESCRIPTION	NOTES	KG/LBS						
513911BI 513975GM 513934NS	1 x 50W	    108770XX ALO HRGS 50W 12V GU5.3 QR-CB	0,16/0,4						
									
M11Q	<table border="1"> <thead> <tr> <th>CODE</th> <th>DESCRIPTION</th> <th>NOTES</th> <th>KG/LBS</th> </tr> </thead> <tbody> <tr> <td>513811BI 513875GM 513834NS</td> <td>1 x 35W</td> <td>    110370XX ALO HRGS 35W 12V GZ4 MR11</td> <td>0,13/0,3</td> </tr> </tbody> </table>	CODE	DESCRIPTION	NOTES	KG/LBS	513811BI 513875GM 513834NS	1 x 35W	    110370XX ALO HRGS 35W 12V GZ4 MR11	0,13/0,3
CODE	DESCRIPTION	NOTES	KG/LBS						
513811BI 513875GM 513834NS	1 x 35W	    110370XX ALO HRGS 35W 12V GZ4 MR11	0,13/0,3						
<p>BI GM NS </p>									



Apparecchio da incasso per lampadine alogene a bassa tensione 12V, struttura in metallo verniciato grigio. Trasformatore non incluso.

Recessed spotlight for low voltage halogen bulbs 12V. Structure metal grey painted. Transformer not included.

Spot à encastrer pour ampoules halogènes à basse tension 12V. Structure en métal verni gris. Transformateur pas inclus.

Einbaustrahler für halogen Niedervolt 12V. Körper aus metal grau lackiert. Transformator nicht beigelect.

Spot a emprotar para bombillas halogenas 12V. Estructura en metallo barnizado gris. Transformador non incluso.

				
MINIBASKET 1F	CODE XFWL4/XX	DESCRIPTION 1 x 50W	NOTES   108770XX ALO HRGS 50W 12V GU5.3 QR-CB	KG/LBS 0,3/0,7
				
MINIBASKET 2F	CODE XFWL4/2X	DESCRIPTION 2 x 50W	NOTES   108770XX ALO HRGS 50W 12V GU5.3 QR-CB	KG/LBS 0,53/1,2
				
MINIBASKET 4F	CODE XFWL4/4X	DESCRIPTION 4 x 50W	NOTES   108770XX ALO HRGS 50W 12V GU5.3 QR-CB	KG/LBS 1,1/2,4
				



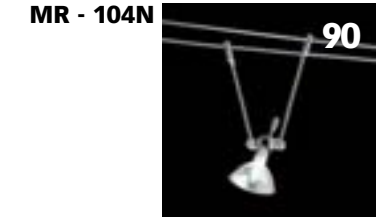
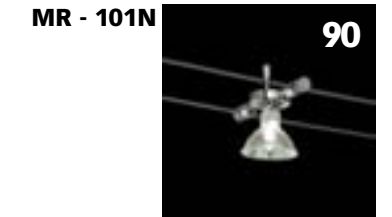
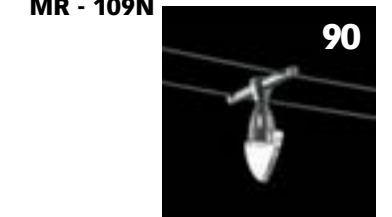
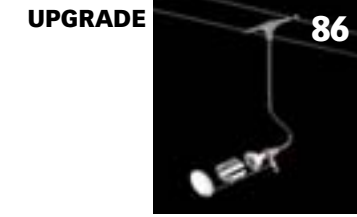
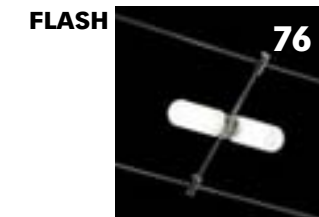
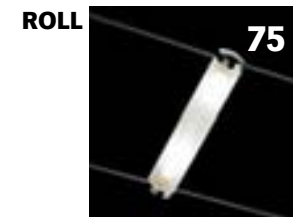
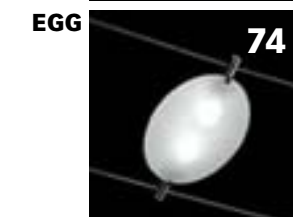



Tecno è adatto ad ogni tipo di realizzazione sia in ambienti pubblici che in abitazioni e può essere utilizzato nella decorazione di vetrine. Particolari in acciaio o ottone cromato, diffusori in alluminio anodizzato, cromato e in vetro soffiato o stampato, lampadine alogene bispina fino a 50W e dicroiche fino a 50W. Trasformatore non incluso.

Tecno looks equally good in public buildings, private homes and shop windows.

Tecno features steel or chrome-plated design details, diffusers in anodised aluminium and chrome and blown or pressed glass, halogen bulbs of up to 50W and dichroic bulbs of up to 50W. Transformer not included.

Tecno s'adapte à tout type de réalisation que ce soit dans des lieux publics ou dans des habitations privées et peut être utilisé pour la décoration de vitrines. Détails en acier et laiton chromé, diffuseurs en aluminium anodisé et chromé et en verre soufflé ou moulé, ampoules halogènes jusqu'à 50W et dichroïques jusqu'à 50W. Transformateur pas inclus.

Tecno ist für alle Einsatzarten sowohl im öffentlichen Bereich als auch in Privatwohnungen geeignet, und kann für die Schaufensterdekoration eingesetzt werden. Einzelteile aus Chromstahl oder verchromtem Messing und Lampenschirme aus Eloxal und verchromtem Aluminium, aus geblasenem Glas oder Preßglas, Halogenlampen und dichroitische Glühlampen bis zu 50W. Transformator nicht beigelegt.

Tecno es adecuado para cualquier tipo de realización sea en ambientes públicos que en viviendas y puede ser utilizado para la decoración de escaparates. Detalles en acero o latón cromado, pantallas en aluminio anodizado y cromado y en vidrio soplado o estampado, bombillas halógenas de doble enchufe hasta 50W y dicroicas hasta 50W. Transformador non incluso.

SISTEMA EMME - 15/5,9' interasse width
entraxe
distanz
distancia entre ejes



LUCE I 20 	CODE 104210NI	DESCRIPTION 2 x 10W	NOTES 108800XX ALO 10W 12V SV8.5-8	KG/LBS 0,03/0,1
LUCE F94 	CODE 104920CR 104920RA	DESCRIPTION 1 x 50W	NOTES 108770XX ALO HRGS 50W 12V GU5.3 QR-CB 108680XX ALO HSGST 50W 12V GY6.35 QT12	KG/LBS 0,07/0,2
LUCE F95 	CODE 105510CR 105510RA	DESCRIPTION 1 x 50W	NOTES 108770XX ALO HRGS 50W 12V GU5.3 QR-CB 108680XX ALO HSGST 50W 12V GY6.35 QT12	KG/LBS 0,13/0,3

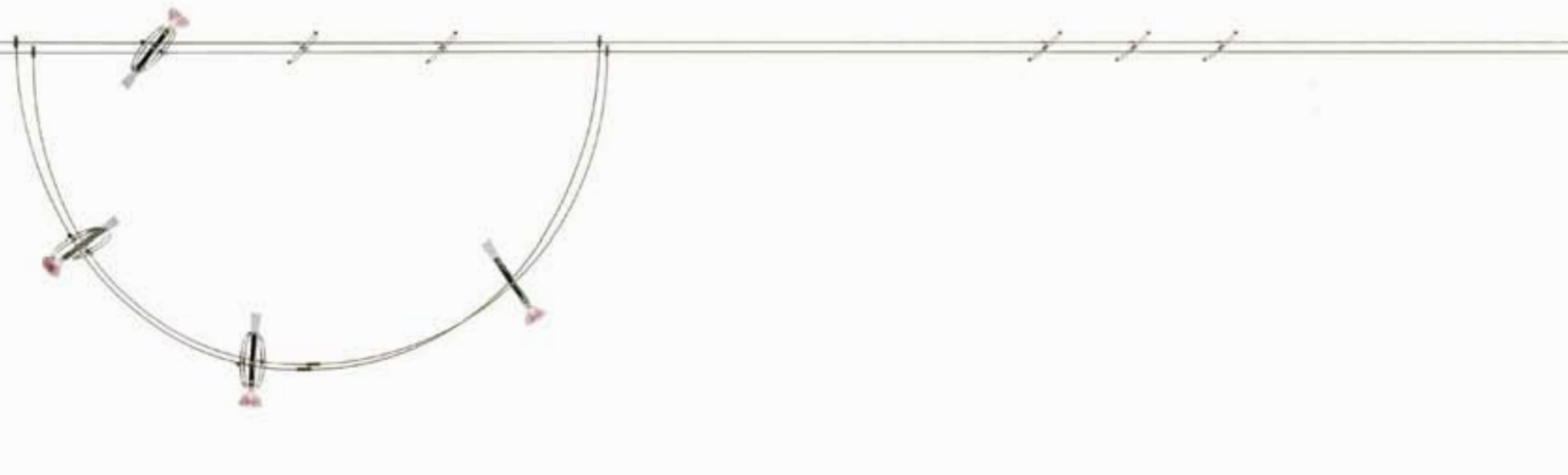

FINITURA CROMO
CHROMED FINISHING



FINITURA RAME
COPPER FINISHING

LUCE F97	CODE 103380CR	DESCRIPTION 1 x 50W	NOTES 108770XX ALO HRGS 50W 12V GU5.3 QR-CB	KG/LBS 0,3/0,7	
LUCE P	CODE 104360NI 104360RA	DESCRIPTION 1 x 50W	NOTES 108770XX ALO HRGS 50W 12V GU5.3 QR-CB	KG/LBS 0,15/0,3	
F016	CODE 110090CR 110090GM 110090RA	DESCRIPTION 1 x 50W	NOTES 108770XX ALO HRGS 50W 12V GU5.3 QR-CB	KG/LBS 0,1/0,2	

IP20

FARETTO	CODE 107280BL 107280RO 111220BL 111220RO	DESCRIPTION 1 x 50W finitura cromo chromed finishing 1 x 50W finitura rame copper finishing	NOTES 108770XX ALO HRGS 50W 12V GU5.3 QR-CB	KG/LBS 0,08/0,2 0,13/0,3	
LUCE F02	CODE 109200CR	DESCRIPTION 1 x 50W	NOTES 108770XX ALO HRGS 50W 12V GU5.3 QR-CB	KG/LBS 0,1/0,2	
LUCE F2004	CODE 106240XX	DESCRIPTION 1 x 75W	NOTES 111820XX ALO HMGS 75W 12V G53	KG/LBS 0,1/0,2	

IP20

Due conchiglie in vetro sabbato affiancate per illuminare abitazioni, vetrine, negozi, stand.
Corpo cromato o rame.
Trasformatore non incluso.

Two sanded glass shells to light houses, shops, stand.
Chromed or copper frame.
Transformer not included.

Deux coquilles en verre dépoli réunies par éclairer maisons, vitrines, boutiques, stands.
Structure chromée ou cuivre.
Transformateur pas inclus.

Zwei Muschel-Halbschalen aus Glas satiniert, für Wohnraumbeleuchtung, Verkaufsvitrinen und Ausstellungsstände.
Gehäuse verchromt oder Kupfer.
Transformator nicht beigelegt.

Dos couchas en vidrio arenoso por iluminar habitaciones, aparadores, tiendas, stand. Estructura cromo o cobre.
Transformador non incluso.

SISTEMA EMME - 15/5,9' interasse
width
entraxe
distanz
distancia entre ejes

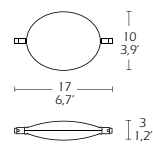

EGG	CODE	DESCRIPTION	NOTES	KG/LBS
	109140CR 109140RA	2 x 20W	108700XX ALO HSGST 20W 12V G4 QT4	0,2/0,4

CR RA



IP20

Cilindro in vetro sabbato con due lampadine.
Corpo cromato o rame.
Trasformatore non incluso.

Sanded glass cylinder with two halogen dual-pin bulbs. Chromed or copper frame.
Transformer not included.

Cylindre en verre dépoli avec deux ampoules. Structure chromée ou cuivre.
Transformateur pas inclus.

Glaszylinder, satiniert mit zwei Halogenlampen. Gehäuse verchromt oder Kupfer. Transformator nicht beigelegt.

Cilindro en vidrio arenoso con dos bombillas. Estructura cromo o cobre.
Transformador non incluso.

SISTEMA EMME - 15/5,9' interasse
width
entraxe
distanz
distancia entre ejes

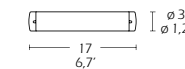

ROLL	CODE	DESCRIPTION	NOTES	KG/LBS
	109160CR 109160RA	2 x 35W	108760XX ALO HSGST 35W 12V GY6.35 QT12	0,14/0,3

CR RA

IP20



FINITURA CROMO
CHROMED FINISHING



FINITURA RAME
COPPER FINISHING

Punti luce in vetro sabbato con una o due lampadine per qualsiasi soluzione luminosa. Corpo cromato o ramato con diffusori in vetro sabbato. Trasformatore non incluso.







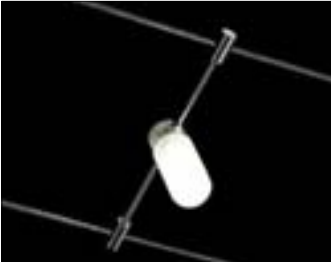
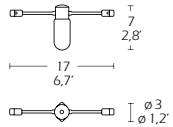

Light points in sanded glass with one or two bulbs for any lighting solution. Chromed or copper frame with sanded glass diffusers. Transformer not included.

Spots en verre dépoli avec une ou deux ampoules pour chaque nécessité d'éclairage. Structure chromée ou cuivre avec diffuseur en verre sablé. Transformateur pas inclus.

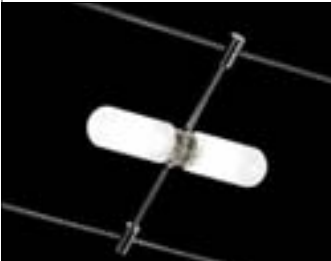
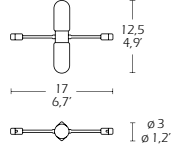
Lichtpunkt aus satiniertem Glas, mit ein oder zwei Lichtquellen für verschiedene Beleuchtungslösungen. Gehäuse verchromt oder Kupfer mit sandgestrahltes glaser diffusor. Transformator nicht beigelect.

Punto de luz en vidrio arenoso con una o dos bombillas for cualquier solución luminosa. Estructura cromo o cobre con difusor en vidrio arenoso. Transformador non incluso.

SISTEMA EMME - 15/5,9' interasse
width
entraxe
distanz
distancia entre ejes

				
FLASH 1	CODE 109150CR 109150RA	DESCRIPTION 1 x 50W	NOTES  108680XX ALO HSGST 50W 12V GY6.35 QT12	KG/LBS 0,7/0,2
				
FLASH 2	CODE 109170CR 109170RA	DESCRIPTION 2 x 50W	NOTES  108680XX ALO HSGST 50W 12V GY6.35 QT12	KG/LBS 0,1/0,2
				



Una illuminazione elegante e dinamica, adatta sia ad ambienti pubblici che abitazioni. Si possono regolare in altezza rispetto al filo, ottenendo sapienti effetti dinamici di movimento. Sono integrati da un faretto regolabile con una elegante impugnatura rossa traslucida. Particolari in acciaio e ottone cromato, diffusori in policarbonato. Trasformatore non incluso.

Elegant, dynamic lighting that is suitable for public buildings and domestic environments. The height of the various components can be adjusted to create movement. The range includes an adjustable spotlight with an elegant translucent red grip. Design details in steel and chrome-plated brass, polycarbonate diffusers. Transformer not included.

Un éclairage élégant et dynamique, conçu aussi bien pour des locaux publics que pour des habitations. Ils peuvent être réglés en hauteur par rapport au fil en obtenant de savants effets dynamiques de mouvement. Ils sont complétés par un spot réglable avec une élégante poignée rouge translucide. Détails en acier et laiton chromé, diffuseurs en polycarbonate. Transformateur pas inclus.

Eine erlesene und dynamische Beleuchtung, sowohl für den öffentlichen Bereich als auch für Privatwohnungen geeignet. Die Elemente sind höhenverstellbar, wodurch gekonnte, dynamische Bewegungseffekte erzielt werden. Zur Ergänzung ist ein verstellbarer Strahler mit einem eleganten Griff in durchscheinendem rot verfügbar. Einzelteile aus Chromstahl und verchromtem Messing, Lampenschirme aus Polykarbonat. Transformator nicht beigelegt.

Una iluminación elegante y dinámica, adecuada tanto en ambientes públicos como en viviendas. Se pueden regular en altura con respecto al cable, obteniendo hábiles efectos dinámicos de movimiento. Están integrados por un foco regulable con una elegante empuñadura roja translúcida. Detalles en acero y latón cromado, pantallas en policarbonato. Transformador non incluso.



<p>ALI</p>	<table border="1"> <thead> <tr> <th>CODE</th> <th>DESCRIPTION</th> <th>NOTES</th> <th>KG/LBS</th> </tr> </thead> <tbody> <tr> <td>107150BI</td> <td>1 x 35W corpo a righe striped frame</td> <td>108760XX ALO HSGST 35W 12V GY6.35 QT12</td> <td>0,1/0,2</td> </tr> </tbody> </table>	CODE	DESCRIPTION	NOTES	KG/LBS	107150BI	1 x 35W corpo a righe striped frame	108760XX ALO HSGST 35W 12V GY6.35 QT12	0,1/0,2
CODE	DESCRIPTION	NOTES	KG/LBS						
107150BI	1 x 35W corpo a righe striped frame	108760XX ALO HSGST 35W 12V GY6.35 QT12	0,1/0,2						
<p>ALI APERTE</p>	<table border="1"> <thead> <tr> <th>CODE</th> <th>DESCRIPTION</th> <th>NOTES</th> <th>KG/LBS</th> </tr> </thead> <tbody> <tr> <td>107160BI</td> <td>1 x 35W fornito con set di astine regolabili in altezza complete with set of rods adjustable in height</td> <td>108760XX ALO HSGST 35W 12V GY6.35 QT12</td> <td>0,1/0,2</td> </tr> </tbody> </table>	CODE	DESCRIPTION	NOTES	KG/LBS	107160BI	1 x 35W fornito con set di astine regolabili in altezza complete with set of rods adjustable in height	108760XX ALO HSGST 35W 12V GY6.35 QT12	0,1/0,2
CODE	DESCRIPTION	NOTES	KG/LBS						
107160BI	1 x 35W fornito con set di astine regolabili in altezza complete with set of rods adjustable in height	108760XX ALO HSGST 35W 12V GY6.35 QT12	0,1/0,2						
<p>VOLO CON CODA</p>	<table border="1"> <thead> <tr> <th>CODE</th> <th>DESCRIPTION</th> <th>NOTES</th> <th>KG/LBS</th> </tr> </thead> <tbody> <tr> <td>107170BI</td> <td>1 x 35W fornito con set di astine regolabili in altezza complete with set of rods adjustable in height</td> <td>108760XX ALO HSGST 35W 12V GY6.35 QT12</td> <td>0,1/0,2</td> </tr> </tbody> </table>	CODE	DESCRIPTION	NOTES	KG/LBS	107170BI	1 x 35W fornito con set di astine regolabili in altezza complete with set of rods adjustable in height	108760XX ALO HSGST 35W 12V GY6.35 QT12	0,1/0,2
CODE	DESCRIPTION	NOTES	KG/LBS						
107170BI	1 x 35W fornito con set di astine regolabili in altezza complete with set of rods adjustable in height	108760XX ALO HSGST 35W 12V GY6.35 QT12	0,1/0,2						
<p>BI</p>	<p>180° IP20</p>								



Disponibile in tre colori e tre dimensioni, è integrato da un faretto a posizione regolabile, dotato di una impugnatura sferica blu traslucida. Particolari in acciaio e ottone cromato, diffusori in policarbonato serigrafato. Trasformatore non incluso.







Available in three colours and three sizes, also comes with adjustable spotlights and translucent blue spherical grips. Steel and chrome-plated design details, silk-screen printed polycarbonate diffusers. Transformer not included.

Décliné en trois coloris et trois dimensions. Il est complété par un spot à position réglable et est doté d'une poignée sphérique bleu translucide. Détails en acier et laiton chromé, diffuseurs en polycarbonate sérigraphié. Transformateur pas inclus.

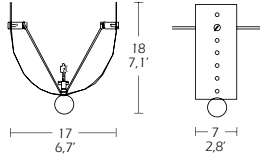
Drei Farben und drei Größen verfügbar. Es wird von einem verstellbaren Strahler ergänzt, der mit einem blau durchscheinenden, kugelförmigen Griff ausgestattet ist Einzelteile aus Chromstahl und verchromtem Messing, Lampenschirme aus Polykarbonat mit Siebdruck. Transformator nicht beigelect.

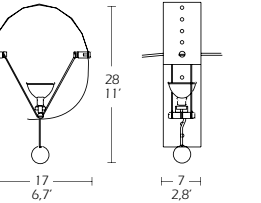
Disponible en tres colores y tres dimensiones. Está integrado por un foco de posición regulable, dotado de una empuñadura esférica azul translucido. Detalles en acero y latón cromado, pantallas en policarbonato serigrafado. Transformador non incluso.

SISTEMA EMME - 15/5,9' interasse width
entraxe
distanz
distancia entre ejes

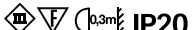
				
NASTRO SEMPLICE	CODE 107190BL 107190GI 107190GM	DESCRIPTION 1 x 35W	NOTES  108760XX ALO HSGST 35W 12V GY6.35 QT12	KG/LBS 0,1/0,2
				
NASTRO CHIUSO	CODE 107200BL 107200GI 107200GM	DESCRIPTION 1 x 35W	NOTES  108760XX ALO HSGST 35W 12V GY6.35 QT12	KG/LBS 0,1/0,2
				

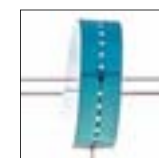

BL
Corpo arcobaleno verde azzurro
Green/light-blue rainbow frame
Corps arc-en-ciel vert bleu clair
Gehäuse Regenbogen grün hellblau
Estructura arco iris verde azul.

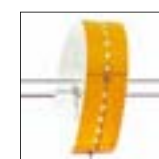

GI
Corpo arcobaleno giallo rosso
Red/yellow rainbow frame
Corps arc-en-ciel jaune rouge
Gehäuse Regenbogen gelb rot
Estructura arco iris amarillo rojo.



GM
Corpo arcobaleno argento
Silver rainbow frame
Corps arc-en-ciel argent
Gehäuse Regenbogen silber
Estructura arco iris plata.



Sistema Fiori con corpi colorati che si possono utilizzare sia su linee orizzontali che in particolare sugli elementi aggiuntivi geometrici disponibili a catalogo. Questo prato luminoso e colorato può essere intervallato da faretto dicroico orientabili. Particolari in ottone o acciaio cromato, diffusori in policarbonato. Trasformatore non incluso.







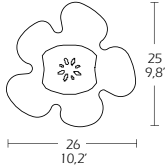

Fiori with colourful fixtures can be mounted onto horizontal lines or optional decorative components in geometrical shapes that can be chosen from our catalogue. This bright, colourful "meadow" can be speckled with adjustable dichroic spotlights. Details in brass or chrome-plated steel, polycarbonate diffusers. Transformer not included.

Le système Fiori, avec des corps colorés pouvant être utilisés aussi bien sur des lignes horizontales que sur des éléments géométriques supplémentaires en particulier et figurant dans le catalogue. Ce pré lumineux et coloré peut être entrecoupé par des spots dichroïques et orientables. Détails en laiton ou en acier chromé, diffuseurs en polycarbonate. Transformateur pas inclus.

System Fiori, mit seinen farbigen Gehäusen, die sowohl an horizontalen Seilen als auch an den laut Katalog lieferbaren geometrischen Zusatzelementen montiert werden können. Diese farbige Wiese voller Licht kann mit verstellbaren dichroitischen Strahlern abgewechselt werden. Einzelteile aus verchromtem Messing und Chromstahl, Lampenschirme aus Polykarbonat. Transformator nicht beigelegt.

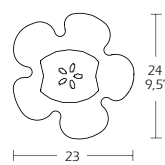
Fiori, con cuerpos coloreados que se pueden utilizar sobre líneas horizontales y especialmente sobre los elementos geométricos adicionales disponibles en el catalogo. Este prado luminoso y coloreado puede ser distanciado por focos dicroicos orientables. Detalles en latón o acero cromado, pantallas en policarbonato. Transformador non incluso.

SISTEMA EMME - 15/5,9' interasse width
entraxe
distanz
distancia entre ejes

									
<p>FIORE SIMMETRICO</p>	<table border="1"> <thead> <tr> <th>CODE</th> <th>DESCRIPTION</th> <th>NOTES</th> <th>KG/LBS</th> </tr> </thead> <tbody> <tr> <td>107130AR 107130BL 107130VE</td> <td>1 x 35W fornito con set di astine per montaggio sia a filo che su elementi DR complete with set of rods for DR elements and line mount</td> <td> 108760XX ALO HSGST 35W 12V GY6.35 QT12</td> <td>0,08/0,2</td> </tr> </tbody> </table>	CODE	DESCRIPTION	NOTES	KG/LBS	107130AR 107130BL 107130VE	1 x 35W fornito con set di astine per montaggio sia a filo che su elementi DR complete with set of rods for DR elements and line mount	 108760XX ALO HSGST 35W 12V GY6.35 QT12	0,08/0,2
CODE	DESCRIPTION	NOTES	KG/LBS						
107130AR 107130BL 107130VE	1 x 35W fornito con set di astine per montaggio sia a filo che su elementi DR complete with set of rods for DR elements and line mount	 108760XX ALO HSGST 35W 12V GY6.35 QT12	0,08/0,2						
									
<p>FIORE ASIMMETRICO</p>	<table border="1"> <thead> <tr> <th>CODE</th> <th>DESCRIPTION</th> <th>NOTES</th> <th>KG/LBS</th> </tr> </thead> <tbody> <tr> <td>107140AR 107140BL 107140VE</td> <td>1 x 35W fornito con set di astine per montaggio a filo complete with set of rods for line mount</td> <td> 108760XX ALO HSGST 35W 12V GY6.35 QT12</td> <td>0,08/0,2</td> </tr> </tbody> </table>	CODE	DESCRIPTION	NOTES	KG/LBS	107140AR 107140BL 107140VE	1 x 35W fornito con set di astine per montaggio a filo complete with set of rods for line mount	 108760XX ALO HSGST 35W 12V GY6.35 QT12	0,08/0,2
CODE	DESCRIPTION	NOTES	KG/LBS						
107140AR 107140BL 107140VE	1 x 35W fornito con set di astine per montaggio a filo complete with set of rods for line mount	 108760XX ALO HSGST 35W 12V GY6.35 QT12	0,08/0,2						



AR
Corpo arancio
Orange frame
Corps orange
Gehäuse orange
Estructura naranja



BL
Corpo blu
Blue frame
Corps bleu
Gehäuse blau
Estructura azul



VE
Corpo verde
Green frame
Corps vert
Gehäuse grün
Estructura verde

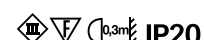



**FINITURA CROMO
CHROMED FINISHING**



**FINITURA RAME
COPPER FINISHING**

Le sospensioni sul tavolo da pranzo per una piacevole atmosfera o sulle vetrine per risaltare gli oggetti. Diffusori in vetro sabbato bianco, corpo in alluminio. Trasformatore non incluso.

















The hanging lamps on the table for a pleasant atmosphere either on the glass-case to show up the articles white sanded glass diffuser, aluminium frame. Transformer not included.

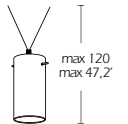







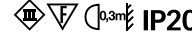

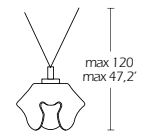



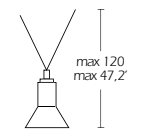

Les suspensions pour la salle à manger donnent une atmosphère agréable ou sur les vitrines pour valoriser les objets. Diffuseurs en verre blanc dépoli, corp en aluminium. Transformateur pas inclus.

Hängeleuchte über den Esstisch für stimmungsvolle Atmosphäre, oder zur Beleuchtung von Schaufensterdekorationen. Diffusor aus Glas satiniert, Gehäuse weiß aus Aluminium. Transformator nicht beigelect.

Las suspensiones por una gustosa atmosfera, o sobre les aparados por resaltar los objetos. Difusor en vidrio blanco arenoso, estructura en aluminio. Transformador non incluso.

SISTEMA EMME - 15/5,9' interasse width
entraxe
distanz
distancia entre ejes

													
CILINDRO M	<table border="1"> <thead> <tr> <th>CODE</th> <th>DESCRIPTION</th> <th>NOTES</th> <th>KG/LBS</th> </tr> </thead> <tbody> <tr> <td>101550BI</td> <td>1 x 50W struttura cromata - vetro bianco chromed frame - white glass</td> <td> 108770XX ALO HRGS 50W 12V GU5.3 QR-CB</td> <td>0,5/1,1</td> </tr> <tr> <td>101550RA</td> <td>1 x 50W struttura ramata - vetro bianco copper-plated frame - white glass</td> <td> 108680XX ALO HSGST 50W 12V GY6.35 QT12</td> <td></td> </tr> </tbody> </table>	CODE	DESCRIPTION	NOTES	KG/LBS	101550BI	1 x 50W struttura cromata - vetro bianco chromed frame - white glass	 108770XX ALO HRGS 50W 12V GU5.3 QR-CB	0,5/1,1	101550RA	1 x 50W struttura ramata - vetro bianco copper-plated frame - white glass	 108680XX ALO HSGST 50W 12V GY6.35 QT12	
CODE	DESCRIPTION	NOTES	KG/LBS										
101550BI	1 x 50W struttura cromata - vetro bianco chromed frame - white glass	 108770XX ALO HRGS 50W 12V GU5.3 QR-CB	0,5/1,1										
101550RA	1 x 50W struttura ramata - vetro bianco copper-plated frame - white glass	 108680XX ALO HSGST 50W 12V GY6.35 QT12											
													
CILINDRO M SOSPENSIONE	<table border="1"> <thead> <tr> <th>CODE</th> <th>DESCRIPTION</th> <th>NOTES</th> <th>KG/LBS</th> </tr> </thead> <tbody> <tr> <td>101530BI</td> <td>1 x 50W sospensioni e cavetti cromo - vetro bianco hanging and chromed cable - white glass</td> <td> 108770XX ALO HRGS 50W 12V GU5.3 QR-CB</td> <td>0,5/1,1</td> </tr> <tr> <td>101530RA</td> <td>1 x 50W sospensioni e cavetti rame - vetro bianco hanging and copper-plated cable - white glass</td> <td> 108680XX ALO HSGST 50W 12V GY6.35 QT12</td> <td></td> </tr> </tbody> </table>	CODE	DESCRIPTION	NOTES	KG/LBS	101530BI	1 x 50W sospensioni e cavetti cromo - vetro bianco hanging and chromed cable - white glass	 108770XX ALO HRGS 50W 12V GU5.3 QR-CB	0,5/1,1	101530RA	1 x 50W sospensioni e cavetti rame - vetro bianco hanging and copper-plated cable - white glass	 108680XX ALO HSGST 50W 12V GY6.35 QT12	
CODE	DESCRIPTION	NOTES	KG/LBS										
101530BI	1 x 50W sospensioni e cavetti cromo - vetro bianco hanging and chromed cable - white glass	 108770XX ALO HRGS 50W 12V GU5.3 QR-CB	0,5/1,1										
101530RA	1 x 50W sospensioni e cavetti rame - vetro bianco hanging and copper-plated cable - white glass	 108680XX ALO HSGST 50W 12V GY6.35 QT12											
													

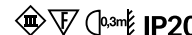
													
GAIA	<table border="1"> <thead> <tr> <th>CODE</th> <th>DESCRIPTION</th> <th>NOTES</th> <th>KG/LBS</th> </tr> </thead> <tbody> <tr> <td>105580BI</td> <td>1 x 50W struttura cromata - vetro bianco chromed frame - white glass</td> <td> 108770XX ALO HRGS 50W 12V GU5.3 QR-CB</td> <td>0,25/0,6</td> </tr> <tr> <td>111160BI</td> <td>1 x 50W struttura ramata - vetro bianco copper-plated frame - white glass</td> <td> 108680XX ALO HSGST 50W 12V GY6.35 QT12</td> <td></td> </tr> </tbody> </table>	CODE	DESCRIPTION	NOTES	KG/LBS	105580BI	1 x 50W struttura cromata - vetro bianco chromed frame - white glass	 108770XX ALO HRGS 50W 12V GU5.3 QR-CB	0,25/0,6	111160BI	1 x 50W struttura ramata - vetro bianco copper-plated frame - white glass	 108680XX ALO HSGST 50W 12V GY6.35 QT12	
CODE	DESCRIPTION	NOTES	KG/LBS										
105580BI	1 x 50W struttura cromata - vetro bianco chromed frame - white glass	 108770XX ALO HRGS 50W 12V GU5.3 QR-CB	0,25/0,6										
111160BI	1 x 50W struttura ramata - vetro bianco copper-plated frame - white glass	 108680XX ALO HSGST 50W 12V GY6.35 QT12											
													
LUCE SO.V.	<table border="1"> <thead> <tr> <th>CODE</th> <th>DESCRIPTION</th> <th>NOTES</th> <th>KG/LBS</th> </tr> </thead> <tbody> <tr> <td>108850XX</td> <td>1 x 50W campanella in vetro bianco - cavetti cromo white glass - chromed cable</td> <td> 108770XX ALO HRGS 50W 12V GU5.3 QR-CB</td> <td>0,14/0,3</td> </tr> <tr> <td>108850RA</td> <td>1 x 50W campanella in vetro bianco - cavetti in rame white glass - copper-plated cable</td> <td> 108680XX ALO HSGST 50W 12V GY6.35 QT12</td> <td></td> </tr> </tbody> </table>	CODE	DESCRIPTION	NOTES	KG/LBS	108850XX	1 x 50W campanella in vetro bianco - cavetti cromo white glass - chromed cable	 108770XX ALO HRGS 50W 12V GU5.3 QR-CB	0,14/0,3	108850RA	1 x 50W campanella in vetro bianco - cavetti in rame white glass - copper-plated cable	 108680XX ALO HSGST 50W 12V GY6.35 QT12	
CODE	DESCRIPTION	NOTES	KG/LBS										
108850XX	1 x 50W campanella in vetro bianco - cavetti cromo white glass - chromed cable	 108770XX ALO HRGS 50W 12V GU5.3 QR-CB	0,14/0,3										
108850RA	1 x 50W campanella in vetro bianco - cavetti in rame white glass - copper-plated cable	 108680XX ALO HSGST 50W 12V GY6.35 QT12											
													



TRASFORMATORE TORO

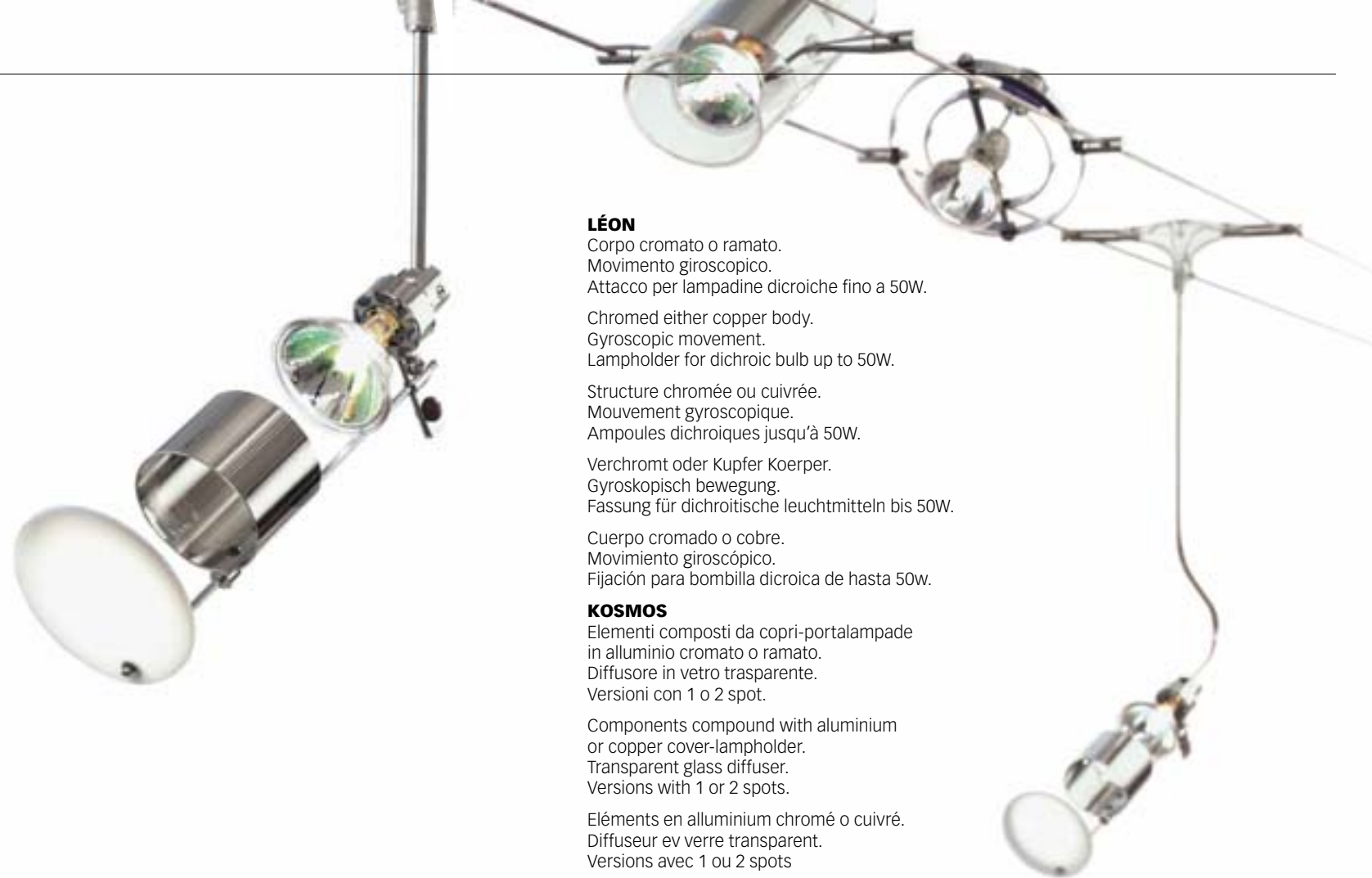

TRASFORMATORE TORO PARETE

**LÉON**

Corpo cromato o ramato.
Movimento giroscopico.
Attacco per lampadine dicroiche fino a 50W.

Chromed either copper body.
Gyroscopic movement.
Lampholder for dichroic bulb up to 50W.

Structure chromée ou cuivrée.
Mouvement gyroscopique.
Ampoules dichroïques jusqu'à 50W.

Verchromt oder Kupfer Koerper.
Gyroskopisch bewegung.
Fassung für dichroitische leuchtmitteln bis 50W.

Cuerpo cromado o cobre.
Movimiento giroscópico.
Fijación para bombilla dicroica de hasta 50w.

KOSMOS

Elementi composti da copri-portalampade
in alluminio cromato o ramato.
Diffusore in vetro trasparente.
Versioni con 1 o 2 spot.

Components compound with aluminium
or copper cover-lampholder.
Transparent glass diffuser.
Versions with 1 or 2 spots.

Eléments en aluminium chromé o cuivré.
Diffuseur ev verre transparent.
Versions avec 1 ou 2 spots

Elementen zusammengesetzt mit verchromt
oder kupfer alu gedeckt fassung. Transparent Glas diffusor.
Version mit 1 oder 2 spot.

Elementos compuestos por cobre-portalámparas
en aluminio cromado o cobre. Difusor en cristal transparente.
Versiones con 1 o 2 spots.

KONUS

Struttura con tige in due dimensioni e portalampada in metallo
cromato o ramato. Versione con spot e filtro anabbagliante.
Si coordina ai riflettori Archimede.

Body with tige in two dimensions and chromed or copper
metal lampholder. Version with spot and anti-dezzle filter.
To arrange with Archimede reflectors.

Structure avec tige en deux mesures avec porte ampoule
en metal chromé ou cuivré. Version avec spot et filtre code.
On peut l'utiliser avec les réflecteurs Archimede.

Strukture mit tige in zwei menge und metal verchromt oder
kupfer metal fassung. Version mit spot und nicht-blended Filter.
In ordnung mit Archimede Reflektoren.

Estructura con tija en dos medidas y portalámparas en metal
cromado o cobre. Versión con foco y filtro antideslumbrante.
Se puede combinar con el reflector.

TORO

Elemento di fissaggio a parete con trasformatore
e tendicavo incorporati fino a 400VA.
Finitura cromato o ramato.

Wall fixing element with transformer and cable
stretcher set included up to 400VA.
Chromed or copper finish.

Elément pour la fixation au mur complet de
transformateur et tendeur de câble jusqu'à 400VA.
Chromé ou cuivré.

Wand fixierung element mit inklusiv trafo und Kaberspanner bis 400VA.
Verchromt oder Kupfer vollendung.

Elemento para la fijación a pared con transformador y tensor
incorporado de hasta 400VA. Acabado en cromado o cobre.

Elementi e corpi illuminanti per
installazione su linee a 12V a 2 e 3
conduttori.
Versioni con finiture cromate
e/o ramate.

Components and lighting sources
for 12v line installations at 2 or 3 wire.
Chromed and or copper finish.









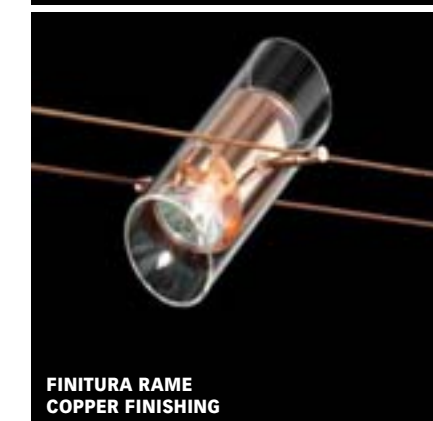

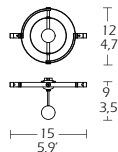

Eléments et spots pour installation sur
lignes à 12v à 2 et 3 conducteurs.
Versions chromées ou cuivrées.

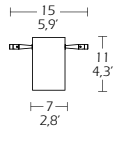
Elementen und Leuchtkoerpern fuer
12v mit 2 oder 3 Leitungs Linien
Installationen. Verchromte oder Kupfere
vollendungen.



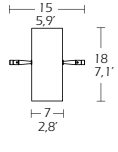

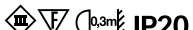

Elemento y cuerpo iluminante para
instalaciones en linea a 12v con 2
o 3 conductores.
Versión con acabado en cromado
y/o cobre.

SISTEMA EMME - 15/5,9' interasse
width
entraxe
distanz
distancia entre ejes

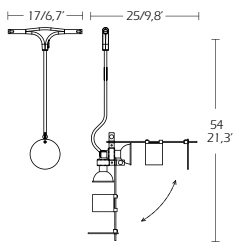
FINITURA CROMO
CHROMED FINISHINGFINITURA RAME
COPPER FINISHING

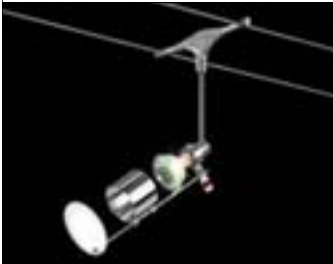
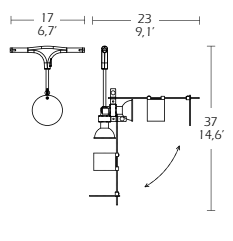
				
LEON	CODE	DESCRIPTION	NOTES	KG/LBS
	533080CR	1 x 50 W struttura cromata chromed frame	 108770XX ALO HRGS 50W 12V GU5.3 QR-CB	0,18/0,4
	533080RA	1 x 50W struttura ramata copper-plated frame	 108680XX ALO HSGST 50W 12V GY6.35 QT12	
				
KOSMOS 1	CODE	DESCRIPTION	NOTES	KG/LBS
	533060CR	1 x 50 W struttura cromata chromed frame	 108770XX ALO HRGS 50W 12V GU5.3 QR-CB	0,57/1,3
	533060RA	1 x 50W struttura ramata copper-plated frame	 108680XX ALO HSGST 50W 12V GY6.35 QT12	
				
KOSMOS 2	CODE	DESCRIPTION	NOTES	KG/LBS
	533070CR	2 x 50 W struttura cromata chromed frame	 108770XX ALO HRGS 50W 12V GU5.3 QR-CB	0,71/1,6
	533070RA	2 x 50 W struttura ramata copper-plated frame	 108680XX ALO HSGST 50W 12V GY6.35 QT12	
				

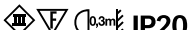

				
KONUS 1	CODE	DESCRIPTION	NOTES	KG/LBS
	533090CR	1 x 50W struttura cromata chromed frame	 108770XX ALO HRGS 50W 12V GU5.3 QR-CB	0,25/0,6
	533090RA	1 x 50W struttura ramata copper-plated frame	 108680XX ALO HSGST 50W 12V GY6.35 QT12	
				
KONUS 2	CODE	DESCRIPTION	NOTES	KG/LBS
	533140CR	1 x 50W struttura cromata chromed frame	 108770XX ALO HRGS 50W 12V GU5.3 QR-CB	0,18/0,4
	533140RA	1 x 50W struttura ramata copper-plated frame	 108680XX ALO HSGST 50W 12V GY6.35 QT12	
				



Al tradizionale Sistema Emme si affianca il nuovo Mini Emme con passo ridotto. La miniaturizzazione delle fonti luminose ed una serie di eleganti faretti, permettono il più svariato utilizzo in stand, vetrine ed abitazioni. Semplicità d'installazione, flessibilità d'impiego, tecnologie costruttive, cura dei particolari, ricchezza dei materiali e raffinatezza nel design, sono le caratteristiche peculiari del nuovo sistema. Trasformatore non incluso.

To the traditional low voltage system Sistema Emme it takes place now the new Mini Emme with axis-base reduced. The miniaturization of lighting elements and different elegant spots, give the use possibility by stand, windows and houses. Installation simplicity, use flexibility, construction technology, care details, richness materials and pleasure design, are the special characteristics of this new system. Transformer not included.

Au Système Emme traditionnel, se rajoute maintenant le nouveau système Mini Emme qui permet un positionnement plus étroit des câbles. La miniaturisation des sources lumineuses et une nouvelle série de spots très esthétiques offrent de nouvelles et nombreuses utilisations dans les stands, les vitrines et les habitations traditionnelles. La simplicité d'installation, la flexibilité d'utilisation, une nouvelle technologie, la qualité des matériaux, le soin apporté aux finitions et en design raffiné sont les caractéristiques particulières de ce nouveau système. Transformateur pas inclus.

Neben dem Traditionellen Niederspannungssystem Sistema Emme wurde als Ergänzung ein neues Mini Emme mit reduziertem Seilabstand entwickelt. Die Lichtelemente sind kleine elegante Spots, einsetzbar als Standbeleuchtung, Schaufenster und Wohnraumausleuchtung. Die Montage ist sehr einfach, flexible Gestaltung Technik und Konstruktion erlauben vielfältige Anwendungsmöglichkeiten und erzeugen eine spezielle Charakteristik des neuen Systems. Transformator nicht beigelegt.

Al tradicional Sistema Emme se le añade el nuevo Mini Emme con paso reducido. La miniaturización de la fuente luminosa y una serie de elegantes faros, permite la mas variada utilidad en stands, escaparates y habitaciones. Semplicitad de installation, flexibilidad de empleo, tecnologia constructiva, cuidado especial del material y refinado diseño son las características peculiares de este nuevo sistema. Transformador non incluso.

SISTEMA MINI EMME - 9/3,5' interasse width
entraxe
distanz
distancia entre ejes

F016 CR GM RA	CODE 110090CR 110090GM 110090RA	DESCRIPTION 1 x 50W		NOTES 108770XX ALO HRGS 50W 12V GU5.3 QR-CB	KG/LBS 0,1/0,2
MR - 109N CR GM	CODE 110040CR 110040GM	DESCRIPTION 1 x 20W		NOTES 108700XX ALO HSGST 20W 12V G4 QT4	KG/LBS 0,24/0,5 0,2/0,4
MR - 101N CR GM	CODE 110010CR 110010GM	DESCRIPTION 1 x 50W		NOTES 108770XX ALO HRGS 50W 12V GU5.3 QR-CB	KG/LBS 0,15/0,3
MR - 104N CR GM	CODE 110020CR 110020GM	DESCRIPTION 1 x 50W		NOTES 108770XX ALO HRGS 50W 12V GU5.3 QR-CB	KG/LBS 0,12/0,3 0,1/0,2

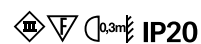



m SISTEMA MINI EMME interasse 9/3,5'
width 9/3,5'

M SISTEMA EMME interasse 15/5,9'
width 15/5,9'

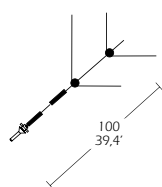

ANGOLARE O
104450CR

Elemento aggiuntivo per linee ad angolo orizzontale.
Additional element for horizontal angle lines.

CR

m M

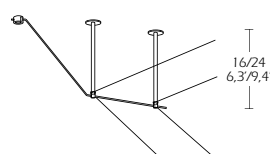

ANGOLARE SOFFITTO

103390CR	H = 16/6,3'
103390RA	
104560CR	H = 24/9,5'
104560RA	

Angolare di linea a soffitto.
Ceiling angular.

CR RA

M

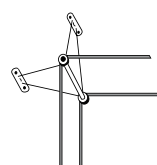

ANGOLARE V

104470CR per SISTEMA EMME
110210CR per SISTEMA MINI EMME

Elemento aggiuntivo per linee ad angolo verticale.
Additional element for vertical angle lines.

CR

m M

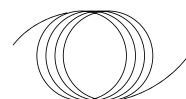

CAVO C

104160NI 104160RA	Lunghezza a richiesta Length by request
111900NI 111900RA	L = 10 m/394'
111910NI 111910RA	L = 20 m/787'
111920NI 111920RA	L = 100 m/3937'
112020NI 112020RA	L = 500 m/19685'

Cavi di linea a bassa tensione
Low voltage cables

111260NI Lunghezza a richiesta
111260RA Length by request

Cavo ricoperto
Isolated wire

NI RA

m M

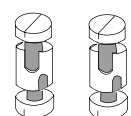

MORSETTI 2F

104380CR
104380RA

Morsetti di connessione corpi al filo.
Serie di due pezzi.

Terminals connecting the frames to the line.
Set of two pieces.

CR RA

m M

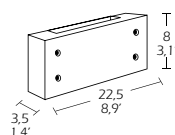

PIASTRA L

104510BI

Piastra isolante in legno.
Insulating wooden plate.

BI

m M

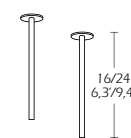

DISTANZIATORE SOFFITTO

105630CR 105630RA	H = 16/6,3'
105640CR 105640RA	H = 24/9,5'

Distanziatori
Spacers

CR RA

m M

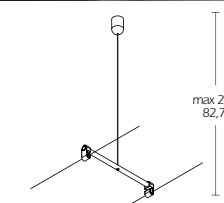

SOSTEGNO LINEA

104460CR per SISTEMA EMME
104460RA per SISTEMA EMME
110230CR per SISTEMA MINI EMME

Sostegno di linea per tratte lunghe.
Line support for long sections.

CR RA

m M

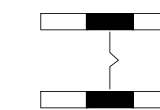
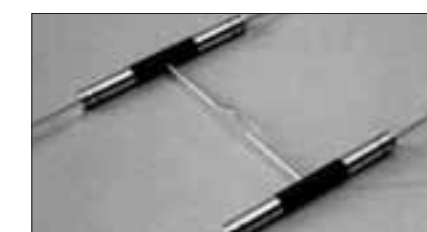

SEPARATORE S

104090CR per SISTEMA EMME
104090RA per SISTEMA EMME
110220CR per SISTEMA MINI EMME

Separatore di tratte di linea
Line section separator

CR RA

m M

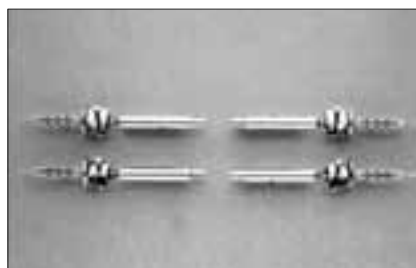

TENDICAVO T
104150CR
104150RA

Set di 4 tenditori
Set of 4 cable-stretcher

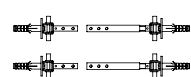
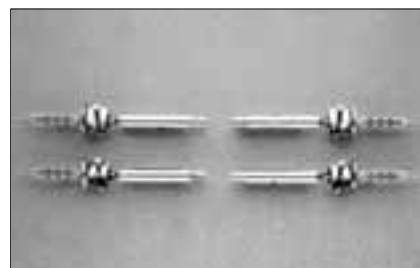

TENDICAVO M02
104540CR
104540RA

Set di 2 tenditori
+ 2 attacchi a muro.
Set of 2 cable-stretcher
+ 2 wall connections.

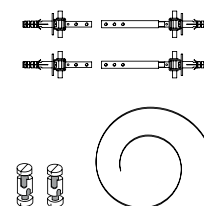

KIT TENDICAVO M02
111130CR
111130RA

L = 1 mt/39,4'
Kit con 4 Tendicavo M02
+ 2 morsetti M2F
+ cavo alimentazione

Kit with 4 Tendicavo M02
+ 2 connectors M2F
+ supply cable

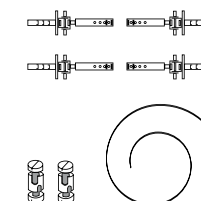

KIT TENDICAVO T
111150CR
111150RA

L = 1 mt/39,4'
Kit con 4 Tendicavo T
+ morsetti M2F
+ cavo alimentazione

Kit with 4 Tendicavo T
+ 2 connectors M2F
+ supply cable

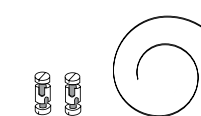

KIT COLLEGAMENTO
111190CR
111190RA

L = 1 mt/39,4'
Kit con 2 morsetti 2F
+ cavo alimentazione

Kit with 2 connectors 2F
+ supply cable

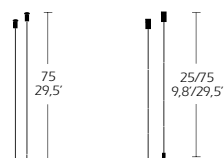

DISCESA D1 - DR1
104220CR
Discesa D1
Down-line D1

104230CR
Discesa DR1 telescopica
Telescopic down-line DR1

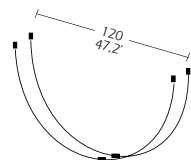

DISCESA D6
104290CR
Discesa di linea a semicerchio
Half-circle down-line

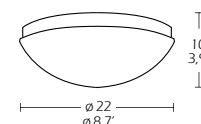

TONDO 300

106720BI 230/12V 300W
106730CR trasformatore
106720GM transformer
106730RA

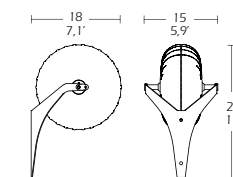

TORO

533010BI 230/12V 300W
533010CR trasformatore e tendicavo
533010GM transformer and cable stretcher set
533010RA

533020BI 230/12V 400W
533020CR trasformatore e tendicavo
533020GM transformer and cable stretcher set
533020RA

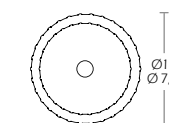

TORO PARETE

533110BI 230/12V 300W
533110CR trasformatore a parete
533110GM wall transformer
533110RA

533120BI 230/12V 400W
533120CR trasformatore a parete
533120GM wall transformer
533120RA



OMNIA ALO 100



OMNIA CONO 102

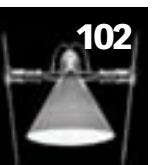

OMNIA E27 103

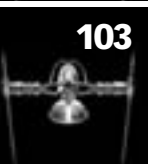

OMNIA E27 FILO HQI 104



OMNIA E27 FILO OPEN HQI 106



OMNIA ECO FILO 108



OMNIA EGG FILO 110

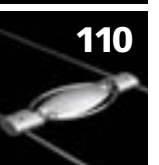

OMNIA EGG FILO HQI 112



OMNIA FLUO 114



OMNIA GLASS 116



OMNIA REFLECTOR 118

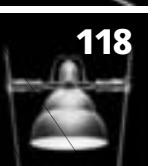

OMNIA TIGE E27 120



COMPONENTI DI LINEA 122

OMNIA ALO 100



OMNIA CONO 102

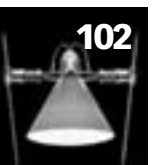

OMNIA E27 103

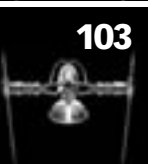

OMNIA E27 FILO HQI 104



OMNIA E27 FILO OPEN HQI 106



OMNIA ECO FILO 108



OMNIA EGG FILO 110

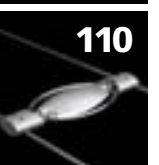

OMNIA EGG FILO HQI 112



OMNIA FLUO 114



OMNIA GLASS 116



OMNIA REFLECTOR 118



OMNIA TIGE E27 120



COMPONENTI DI LINEA 122



Corpo lampada con luce alogena e vetro satinato per luce uniforme e intensa.

Light casing with halogen lamp and mat glass for uniform and strong light.

Corps lampe avec lumière halogène et verre satiné pour un éclairage uniforme et intense.

Beleuchtungskörper mit Halogenlampe und satiniertem Glas für gleichmäßiges intensives Licht.

Cuerpo lampara con luz halogena y cristal opaco para luz uniforme e intensa.

Corpo lampada con luce alogena e vetro bianco per luce in parte diretta e in parte diffusa.

Light casing with halogen lamp and white glass for partially direct diffused light.

Corps lampe avec lumière halogène et verre blanc pour un éclairage en partie direct et en partie diffus.

Beleuchtungskörper mit Halogenlampe und weißem Glas für teilweise direktes und teilweise diffuses Licht.

Cuerpo lampara con luz halogena y cristal blanco para luz en parte directa y parte difusa.

Corpo lampada con luce alogena e vetro serigrafato per luce indiretta.

Light casing with halogen lamp and screen-printed glass for indirect light.

Corps lampe avec lumière halogène et verre sérigraphié pour un éclairage indirect.

Beleuchtungskörper mit Halogenlampe und Glas mit Siebruck für indirektes Licht.

Cuerpo lampara con luz halogena y cristal serigrafado para luz indirecta.



Corpo lampada con luce alogena e vetro satinato per luce uniforme e intensa.

Light casing with halogen lamp and matt glass for uniform and strong light.

Corps lampe avec lumière halogène et verre satiné pour un éclairage uniforme et intense.

Beleuchtungskörper mit Halogenlampe und satiniertem Glas für gleichmäßiges intensives Licht.

Cuerpo lámpara con luz halógena y cristal opaco para luz uniforme e intensa.

SISTEMA OMNIA FILO - 30/11,8' interasse width
entraxe
distanz
distancia entre ejes

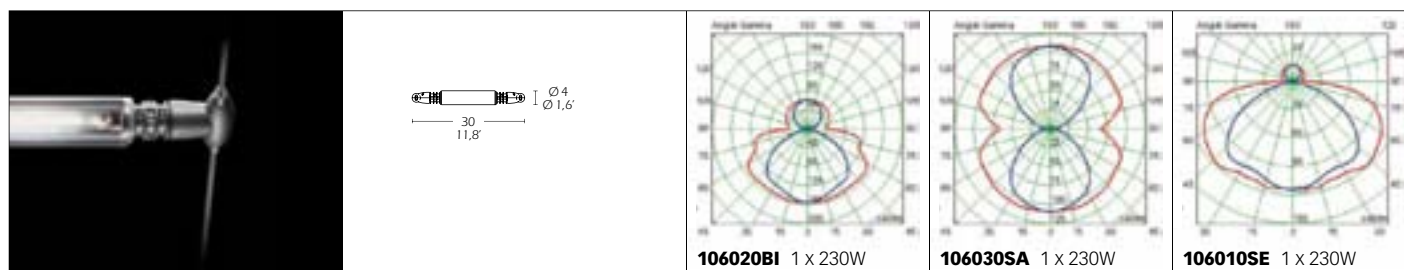

OMNIA ALO	CODE	DESCRIPTION	NOTES	KG/LBS
	106020BI 106030SA 106010SE	1 x 250W	112380ES ALO HDG 230W 230V R7s-114.2 ES	0,3/0,7

BI SA SE

ES 960°

CE IP40

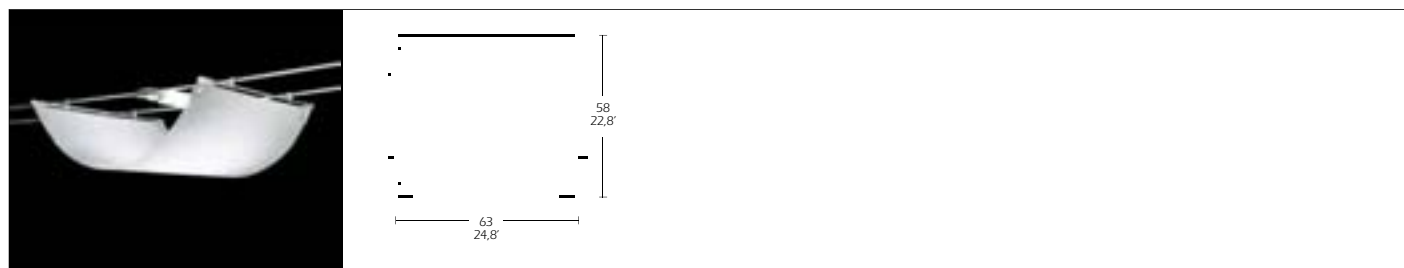

OMNIA TELO	CODE	DESCRIPTION	NOTES	KG/LBS
	106060BI	diffusore policarbonato/polycarbonate diffuseur		0,4/0,9

Diffusore in policarbonato serigrafato per illuminazione omogenea
Polycarbonate screen-printed diffuser for uniform lighting.

Diffuseur en polycarbonate sérigraphié pour un éclairage homogène.

Lampenschirm aus polykarbonat mit Siebdruck für halogene Beleuchtung.

Difusor en policarbonado serigrafado para iluminacion homogénea.

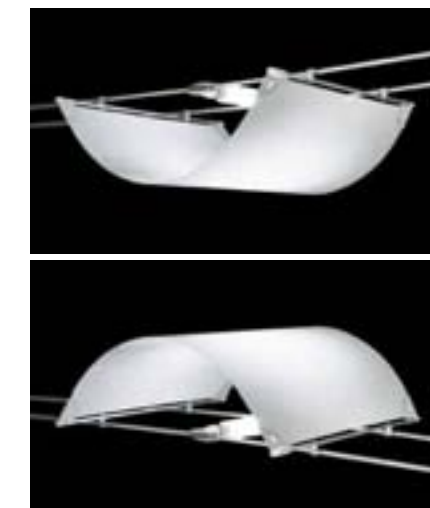

Corpo lampada orientabile con riflettore in policarbonato disponibile in 6 differenti colori.

Adjustable lamp with polycarbonate reflector available in 6 different colours.

Lampe orientable avec le réflecteur en polycarbonate à choix parmi 6 couleurs.

Verstellbarer Beleuchtungskörper mit Polykarbonat-Reflektor erhältlich in 6 verschiedenen Farben.

Lampara orientable con reflector en policarbonato disponible en 6 colores.

SISTEMA OMNIA FILO - 30/11,8' interasse
width
entraxe
distanz
distancia entre ejes



Apparecchio d'illuminazione orientabile in senso orizzontale e verticale.

Adjustable lamp horizontally and vertically revolving.

Lampe orientable en sens horizontal et vertical.

Horizontal und vertikal verstellbare Leuchte.

Lampara orientable en sentido horizontalvertical.

SISTEMA OMNIA FILO - 30/11,8' interasse
width
entraxe
distanz
distancia entre ejes

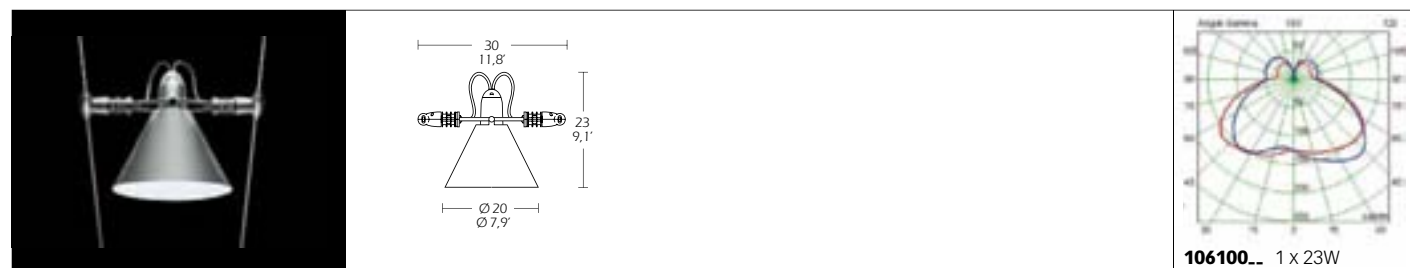
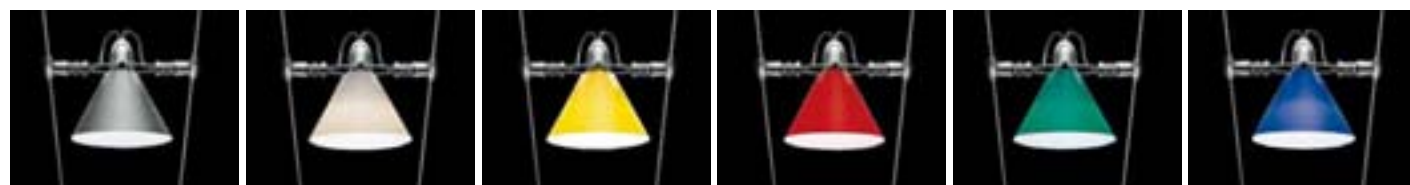

OMNIA CONO	CODE	DESCRIPTION	NOTES	KG/LBS
	106100BI 106100BL 106100GI 106100GM 106100RO 106100VE	1 x 23W corpo grigio metallizzato grey metallic frame	 108040XX FLUO FBT 23W 230V E27	0,28/0,6

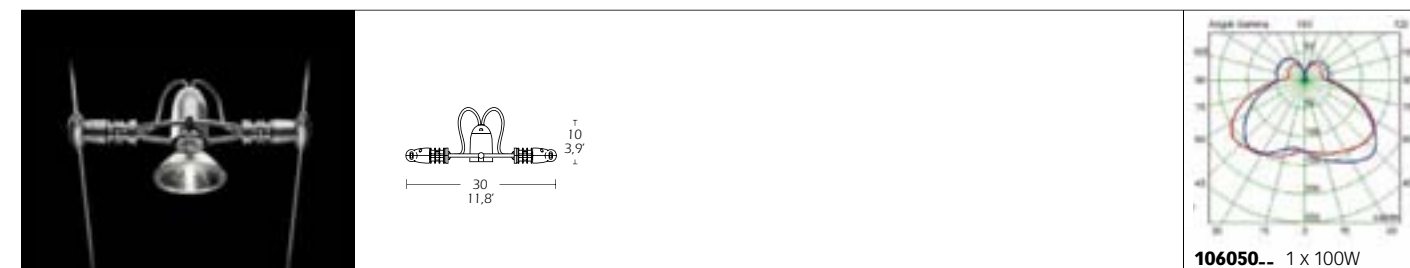

OMNIA E27	CODE	DESCRIPTION	NOTES	KG/LBS
	106050GM	1 x 100W	 108220XX ALO HAGS 100W 230V E27 PAR30	0,28/0,6





Lampada ad alogenuri metallici per installazione su linee Omnia 230V. Corpo in policarbonato verniciato grigio metallizzato.

Metal Halide lamp for installation on Omnia line 230V. Frame in polycarbonate grey metallic painted.

Lampe à décharge pour installation sur lignes Omnia 230V. Corps en polycarbonate verni gris métallisé.

Strahler für Halogenmetaldampfampe zur montage in das Omnia Seilsystem 230V. Gehäuse aus polycarbonat metallic grau lackiert.

Lámpara de halogenuro metálico para instalar su línea Omnia 230V. Cuerpo de policarbonato pintado de gris metalizado.

SISTEMA OMNIA FILO - 30/11,8' interasse
width
entraxe
distanz
distancia entre ejes

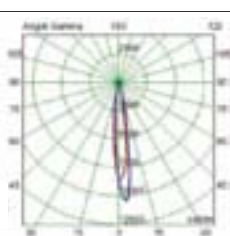
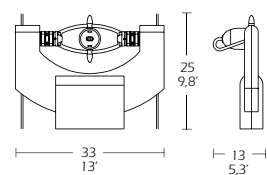

110690.. 1 x 70W

OMNIA E27 FILO HQI	CODE	DESCRIPTION	NOTES	KG/LBS
	110690GM	1 x 70W	 110970XX A.M. MRS 70W 230V E27 PAR30	0,98/2,2

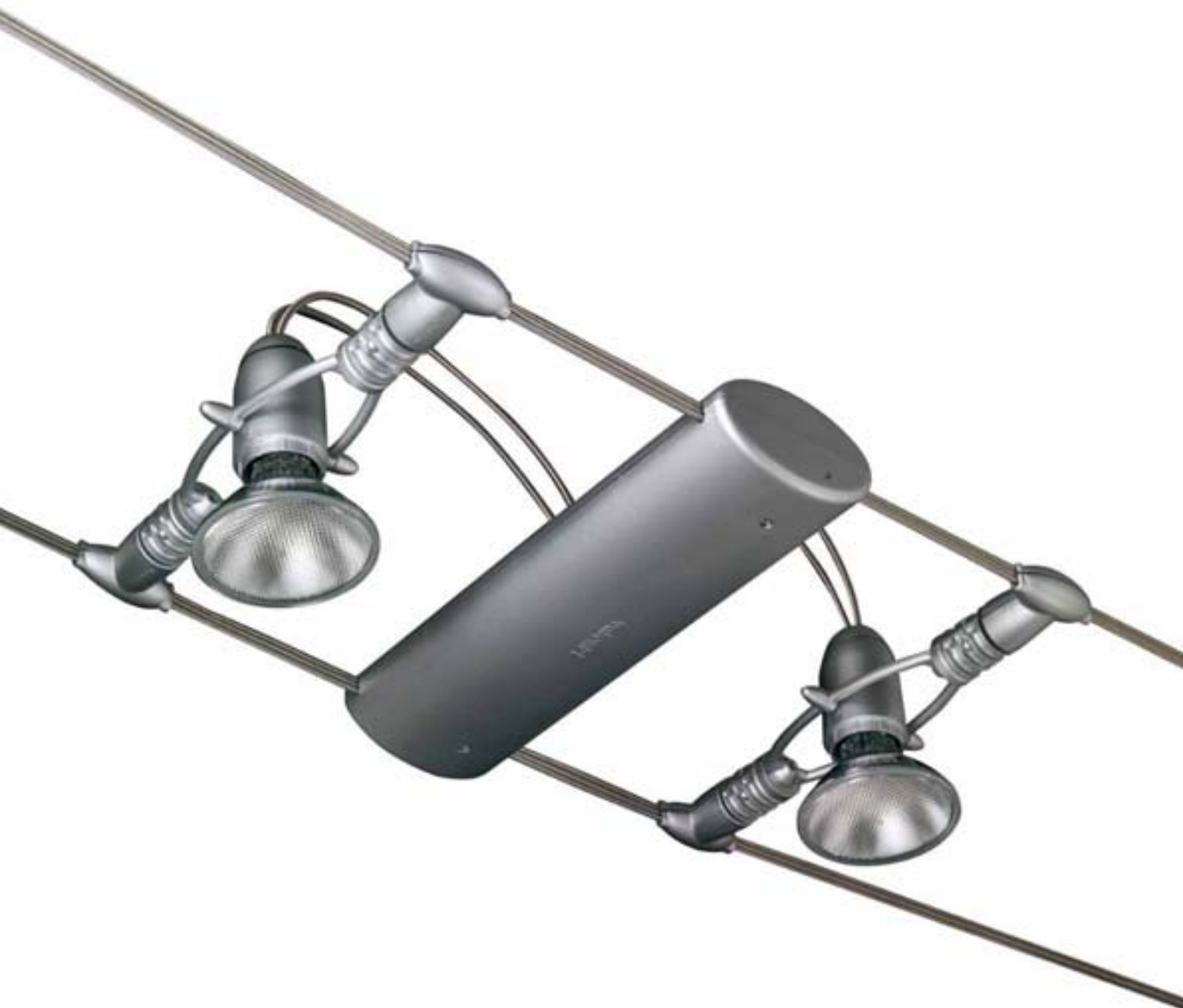

Lampada ad alogenuri metallici per installazione su linea Omnia 230V interasse 300. Tre versioni disponibili: 1 x 70W, 2 x 70W per lampadina E27 PAR30 e 2 x 35W per lampadina E27 PAR20. Per i modelli 2 x 35W e 2 x 70W l'alimentazione delle lampade è separata per assicurare, in caso di guasto interno, il funzionamento di almeno un apparecchio. Finitura grigio metallizzato.

Metal Halide Lamp for installation on Omnia system 230V. Three versions available: 1 x 70W, 2 x 70W for bulb E27 PAR30 e 2 x 35W for bulb E27 PAR20. For models 2 x 35W and 2 x 70W the lamps' supply is separated in order to provide continuous service at least of one device in case of internal failure. Grey metallic finishing.

Lampe aux halogénures métalliques pour installation sur ligne Omnia 230V entraxe 300. Trois versions disponibles: 1 x 70W, 2 x 70W pour ampoule E27 PAR30 et 2 x 35W pour ampoule E27 PAR20. Pour les modèles 2 x 35W et 2 x 70W l'alimentation des lampes est séparée pour assurer, en cas de panne interne, le fonctionnement d'au moins un appareil. Finition gris métallisé.

Metallhalogenlampe zur Installation in der Serie Omnia 230V, Achsabstand 300. In drei Ausführungen erhältlich: 1 x 70W, 2 x 70W für Lampen E27 PAR30 und 2 x 35W für Lampen E27 PAR20. Bei den Modellen 2 x 35W und 2 x 70W erfolgt der Lampenanschluss getrennt, um im Falle eines Defekts im Innern den Betrieb von mindestens einem Gerät zu gewährleisten.

Ausführung Grau metallic. Lámpara de halogenuros metálicos para la instalación sobre la línea Omnia 230V, distancia entre ejes 300. Hay tres versiones disponibles: 1 x 70W, 2 x 70W para lámpara E27 PAR30 y 2 x 35W para lámpara E27 PAR20. Los modelos 2 x 35W y 2 x 70W presentan la alimentación de las lámparas separadas, para garantizar el funcionamiento de al menos una luminaria en caso de fallo interior. Acabado gris metalizado.

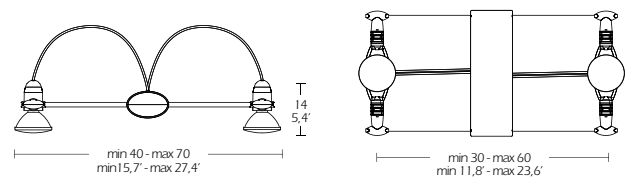

OMNIA E27 FILO OPEN HQI	CODE	DESCRIPTION	NOTES	KG/LBS
	527210GM	1 x 70W	110970XX A.M. MRS 70W 230V E27 PAR30	max 2,4/5,29
	527220GM	2 x 70W		
	527230GM	2 x 35W	112440XX A.M. MRS 35W 230V E27 PAR20	max 2,4/5,29



SISTEMA OMNIA FILO - 30/11,8' interasse
width
entraxe
distanz
distancia entre ejes



Lampada per installazione su linee Omnia 230V. Disponibile in tre lunghezze, 135 cm, 105 cm, 75 cm. Corpo in policarbonato e in estruso di alluminio, verniciati. Diffusore in policarbonato serigrafato, micro Dark Light e frangiluce in lamiera alluminio microforata.

Lamp for installation on Omnia line 230V. Made in three lengths, 135 cm, 105 cm, 75 cm. Frame in polycarbonate and extruded aluminium, painted. Silk-screened polycarbonate diffuser, Dark Light micro reflector and micro holed aluminium light breaker.

Lampe pour installation sur lignes Omnia 230V. Réalisée en trois longueurs, 135 cm, 105 cm, 75 cm. Corps en polycarbonate et en aluminium extrudé, peints. Diffuseur en polycarbonate sérigraphié, micro-réflecteur lumière noire et brise-lumière en tôle d'aluminium microperforée.

Lampe zum Einsatz in der Linie Omnia: 230V Wechselstrom. In drei Längen 135 cm, 105 cm, 75 cm. Gehäuse aus Polykarbonat und fließgepresstem Aluminium, lackiert. Diffusor aus serigraphiertem Polycarbonat, Mikro-Dark Light und Blendschutzraster aus mikroperforiertem Aluminiumblech.

Lampara para instalación en líneas Omnia 230V. Realizada en tres larguras, 135 cm, 105 cm, 75 cm. Cuerpo en policarbonato y en extruido de aluminio barnizados. Pantalla difusora en policarbonato serigrafado.

SISTEMA OMNIA FILO - 30/11,8' interasse
width
entraxe
distanz
distancia entre ejes

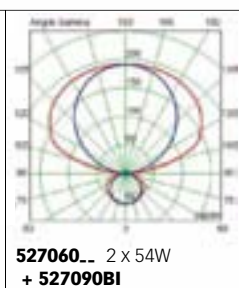
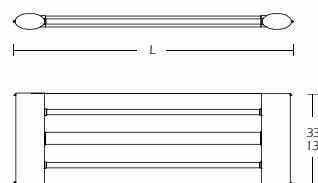

OMNIA ECO FILO	CODE	DESCRIPTION	NOTES	KG/LBS
	527040GM	L = 75/29,5' 2 x 24W	109060XX FL FQ 24W 230V G5 T16	2/4,4
	527050GM	L = 105/41,3' 2 x 39W	109070XX FL FQ 39W 230V G5 T16	2,8/6,2
	527060GM	L = 135/53,1' 2 x 54W	109080XX FL FQ 54W 230V G5 T16	3,6/7,9



527070BI - L = 75/29,5'
527080BI - L = 105/41,3'
527090BI - L = 135/53,1'
Diffusore policarbonato
Frame in polycarbonate

527100AL - L = 51/20,1'
527110AL - L = 81/31,9'
527120AL - L = 111/43,7'
Coppia diffusori Micro Dark Light
Couple frame in Micro Dark Light

527130AL - L = 51/20,1'
527140AL - L = 81/31,9'
527150AL - L = 111/43,7'
Coppia frangiluce microforato
Couple micro holed aluminium
light breaker

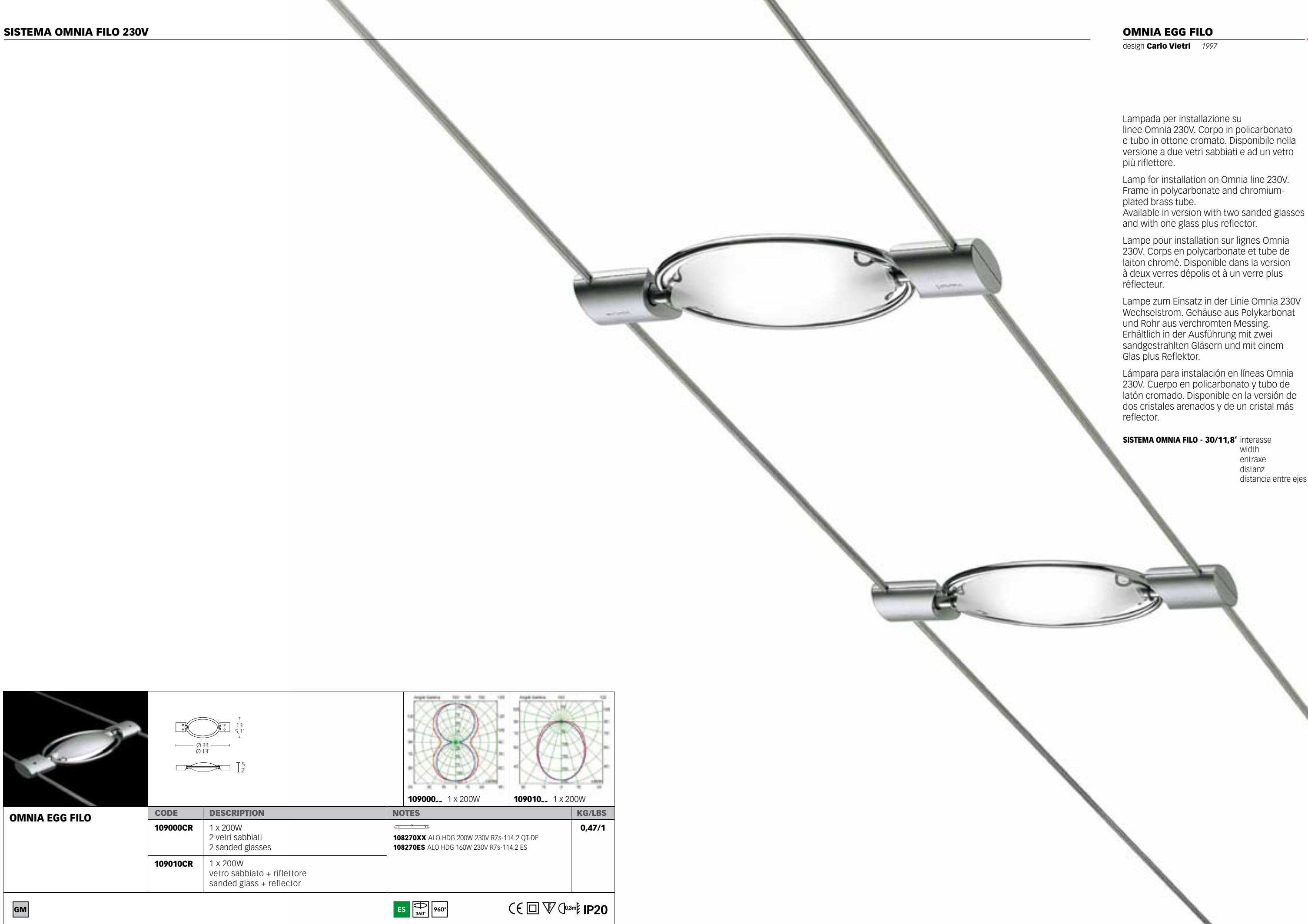

Lampada per installazione su linee Omnia 230V. Corpo in policarbonato e tubo in ottone cromato. Disponibile nella versione a due vetri sabbati e ad un vetro più riflettore.

Lamp for installation on Omnia line 230V. Frame in polycarbonate and chromium-plated brass tube. Available in version with two sanded glasses and with one glass plus reflector.

Lampe pour installation sur lignes Omnia 230V. Corps en polycarbonate et tube de laiton chromé. Disponible dans la version à deux verres dépolis et à un verre plus réflecteur.

Lampe zum Einsatz in der Linie Omnia 230V Wechselstrom. Gehäuse aus Polykarbonat und Rohr aus verchromten Messing. Erhältlich in der Ausführung mit zwei sandgestrahlten Gläsern und mit einem Glas plus Reflektor.

Lámpara para instalación en líneas Omnia 230V. Cuerpo en policarbonato y tubo de latón cromado. Disponible en la versión de dos cristales arenados y de un cristal más reflector.

SISTEMA OMNIA FILO - 30/11,8' interasse
width
entraxe
distanz
distancia entre ejes

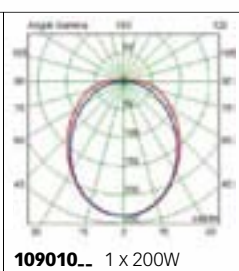
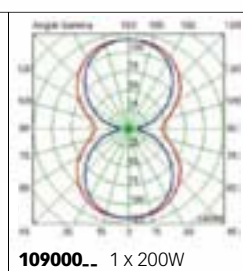
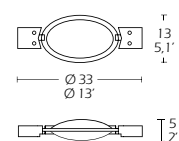

OMNIA EGG FILO	CODE	DESCRIPTION	NOTES	KG/LBS
	109000CR	1 x 200W 2 vetri sabbati 2 sanded glasses	 108270XX ALO HDG 200W 230V R7s-114.2 QT-DE 108270ES ALO HDG 160W 230V R7s-114.2 ES	0,47/1
	109010CR	1 x 200W vetro sabbato + riflettore sanded glass + reflector		





Lampada ad alogenuri metallici per installazione su linee Omnia 230V. Corpo in policarbonato verniciato grigio metallizzato. Tubo in ottone cromato. Disponibile nella versione a due vetri sabbati e ad un vetro più riflettore.

Metal Halide lamp for installation on Omnia line 230V. Frame in polycarbonate grey metallic painted. Chromium-plated brass tube. Available in version with two sanded glasses and with one glass plus reflector.

Lampe à décharge pour installation sur lignes Omnia 230V. Corps en polycarbonate verni gris métallisé, tube de laiton chromé. Disponible dans la version à deux verres dépolis et à un verre plus réflecteur.

Strahler für Halogenmetall dampf-lampe zur montage in das Omnia Seilsystem 230V. Gehäuse aus polycarbonat metallic grau lackiert. Rahmen aus verchromtem Messing. Erhältlich entweder mit zwei sandgestahlten Glasscheiben, oder mit einem Glas und einem Reflektor

Lámpara de halogenuro metálico para instalar su línea Omnia 230V. Cuerpo de policarbonato pintado de gris metalizado. Tubo en latón cromado. Disponible en la versión de dos cristales satinados y un cristal + reflector.

SISTEMA OMNIA FILO - 30/11,8' interasse width
entraxe
distanz
distancia entre ejes

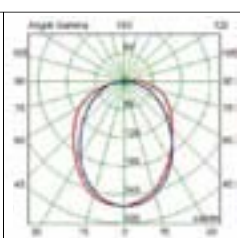
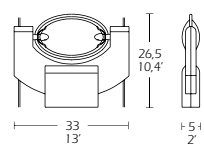

110680.. 1 x 70W

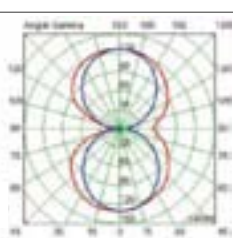

110670.. 1 x 70W

OMNIA EGG FILO HQI	CODE	DESCRIPTION	NOTES	KG/LBS
	110680GM	1 x 70W vetro sabbati + riflettore sanded glass + reflector	110960XX A.M. MT 70W 230V G8.5	1,29/2,8
	110670GM	1 x 70W 2 vetri sabbati 2 sanded glasses		



Apparecchio di illuminazione per il Sistema Omnia. Corpo stampato in tecnopolimeri verniciato grigio alluminio. Monta 2 lampadine fluorescenti da 36W attacco 2G11. Alimentazione elettronica.

Lighting appliance for the Omnia System. Moulded technopolymer frame with a lacquered aluminium finish. Takes 2 36W fluorescent bulbs, 2G11 connection. Features electronic supply control.

Appareil d'éclairage pour le Système Omnia. Corps moulé en technopolymères peint gris aluminium. Accueille 2 ampoules fluorescentes de 36W prise 2G11. Alimentation électronique.

Leuchte für das Omnia-System. Gegossenes Technopolymer-Gehäuse, aluminiumgrau lackiert. Möglichkeit zwei 36W Leuchtstofflampen mit 2G11-Sockel zu installieren. Elektronische Versorgung.

Aparato de iluminación para el Sistema Omnia. Estructura moldeada en tecnopolímeros barnizado gris aluminio. Porta 2 bombillas fluorescentes de 36W unión 2G11. Alimentación electrónica.

SISTEMA OMNIA FILO - 30/11,8' interasse width
entraxe
distanz
distancia entre ejes

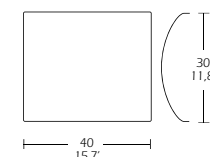

107060AL
Riflettore alluminio
Aluminium reflector

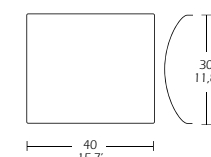

107070BI
Diffusore policarbonato
Frame in polycarbonate

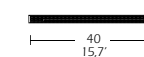

527160AL
Coppia frangiluce microforato
Couple micro holed aluminium
light breaker

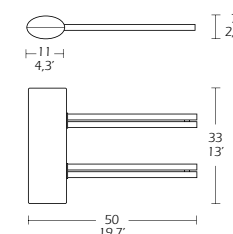
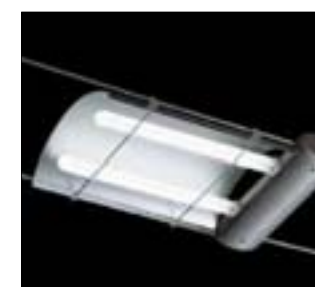

OMNIA FLUO

CODE	DESCRIPTION	NOTES	KG/LBS
107050GM	2 x 36W	108380XX FL FSD 36W 230V 2G11 TC-L	0,88/1,9

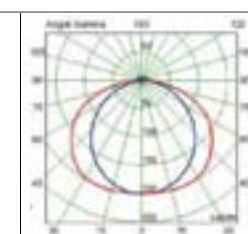

107050GM 2 x 36W + **107060AL**

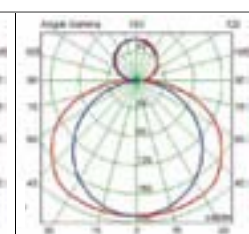

107050GM 2 x 36W + **107070BI**





Apparecchio di illuminazione per il Sistema Omnia 230V a filo. Corpo stampato in tecnopolimeri verniciato grigio alluminio. Lampadina alogena lineare R7s 200W.

Lighting appliance for the Omnia System 230V line mount. Moulded technopolymer frame with a lacquered aluminium. Takes one R7s 200W linear halogen bulb.

Appareil d'éclairage pour le Système Omnia 230V à fil. Corps moulé en technopolymères peint gris aluminium. Ampoule halogène linéaire R7s 200W.

Leuchte für das Omnia-System, 230V, auf Seilen. Gegossenes Technopolymer-Gehäuse, aluminiumgrau lackiert. Lineare Halogenleuchte R7s 200W.

Aparato de iluminación para el Sistema Omnia 230V de cable. Estructura moldeada en tecnopolímeros barnizada gris aluminio. Bombilla halógena lineal R7s 200W.

SISTEMA OMNIA FILO - 30/11,8' interasse
width
entraxe
distanz
distancia entre ejes

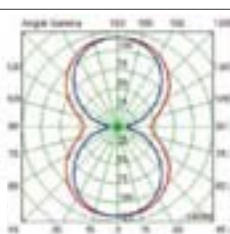
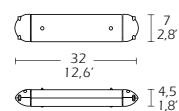

107530... 1 x 200W

OMNIA GLASS	CODE	DESCRIPTION	NOTES	KG/LBS
	107530GM	1 x 200W	 108270XX ALO HDG 200W 230V R7s-114.2 QT-DE 108270ES ALO HDG 160W 230V R7s-114.2 ES	0,55/1,2





Corpo lampada orientabile con riflettore in alluminio anodizzato.

Adjustable lamp with aluminium anodised reflector.

Lampe orientable avec le réflecteur en aluminium anodisé.

Vertellbarer Beleuchtungskörper mit Eloxal-Reflektor.

Lampara orientable con pantalla en aluminio anodizado.

SISTEMA OMNIA FILO - 30/11,8' interasse
width
entraxe
distanz
distancia entre ejes

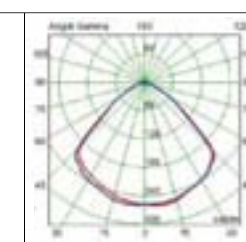
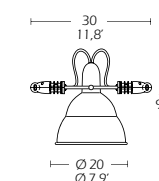

106070.. 1 x 150W

OMNIA REFLECTOR	CODE	DESCRIPTION	NOTES	KG/LBS
	106070GM	1 x 150W	108280XX ALO HSGST 150W 230V E27 108040XX FLUO FBT 23W 230V E27	0,48/1,1

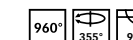

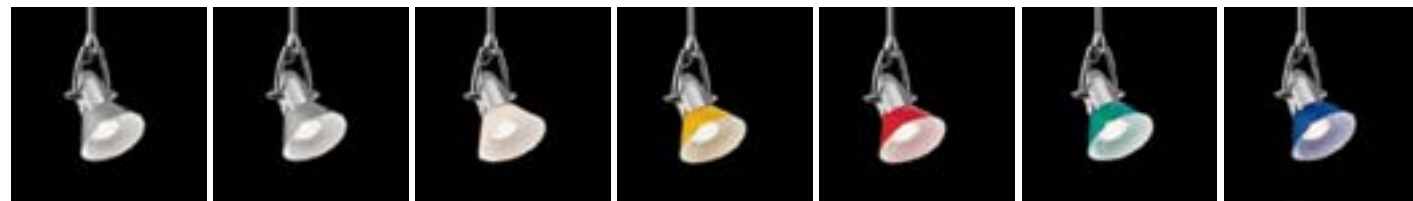

Faretto orientabile con tige per lampadina alogena e ad incandescenza. Riflettore in policarbonato disponibile in 6 differenti colori o in alluminio anodizzato.

Adjustable spot with stem for halogen and incandescent bulb. Polycarbonate reflector available in 6 different colours or in anodized aluminium.

Spot orientable avec tige pour ampoule halogène et incandescence. Réflecteur en polycarbonate disponible en 6 couleurs ou en aluminium anodisé.

Verstellbarer Strahler mit Ständer für Halogen- und Glühlampe. Polykarbonat-Reflektor aus Eloxal oder in 6 verschiedenen Farben erhältlich.

Foco orientable con tige para bombilla halógena y de incandescencia. Reflector en policarbonato disponible en 6 diferentes colores o en aluminio anodizado.

SISTEMA OMNIA FILO - 30/11,8' interasse
width
entraxe
distanz
distancia entre ejes

		<p>106120... 1 x 100W</p>							
<p>OMNIA TIGE E27</p>	<table border="1"> <thead> <tr> <th>CODE</th> <th>DESCRIPTION</th> </tr> </thead> <tbody> <tr> <td>106120BI 106120BL 106120GI 106120GM 106120RO 106120VE</td> <td>1 x 100W riflettore policarbonato polycarbonate reflector</td> </tr> <tr> <td>106120AL</td> <td>1 x 100W riflettore alluminio anodizzato anodized aluminium reflector</td> </tr> </tbody> </table>	CODE	DESCRIPTION	106120BI 106120BL 106120GI 106120GM 106120RO 106120VE	1 x 100W riflettore policarbonato polycarbonate reflector	106120AL	1 x 100W riflettore alluminio anodizzato anodized aluminium reflector	<p>NOTES</p> <p> 108220XX ALO HAGS 100W 230V E27 PAR30</p>	<p>KG/LBS</p> <p>0,33/0,7</p>
CODE	DESCRIPTION								
106120BI 106120BL 106120GI 106120GM 106120RO 106120VE	1 x 100W riflettore policarbonato polycarbonate reflector								
106120AL	1 x 100W riflettore alluminio anodizzato anodized aluminium reflector								
<p>AL BI BL GI GM RO VE</p>		<p></p>	<p>CE </p>						

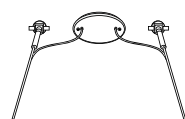

TENDICAVO
106000CR

Gruppo tendicavi per alimentare e tendere la linea elettrica tendicavo con 4 tasselli e 2 basette, interasse 30/11,8'.

Cable tensioner unit.
4 blocks and 2 bases, wheelbase 30/11,8'.

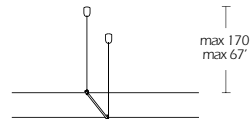

SOSTEGNO
106140GM - H = max 170/67'

Consente di sostenere i cavi nel caso vi siano delle linee superiori ai mt. 8/315', oppure quando vi siano numerosi corpi lampada. Sostegno per linee lunghe.

Cable support for lines more than mt. 8/315' or with many lamps. Support for long section.

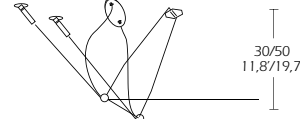

DISTANZIATORE
106150GM

Consente di fissare i tendicavo Omnia a soffitto in assenza di pareti. Escluso tendicavo.

Ceiling fixing component for Omnia tendicavo. Cable-stretcher not included.

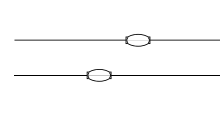

SEPARATORE
106090GM

Permette di separare le linee elettriche per ottenere una doppia accensione.

Separator component to obtain double lighting.

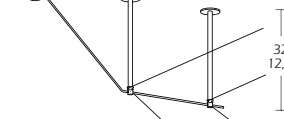

ANGOLARE A SOFFITTO
107090CR

Supporto angolare soffitto. Angular ceiling support.

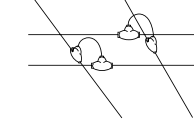

CONNESSIONE
106080GM

Permette di collegare più linee elettriche con un solo punto di alimentazione.

Component to connect more electric lines with only one power supply point.

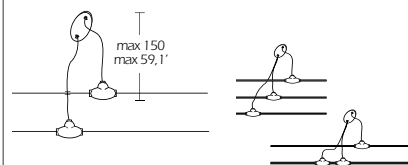

ALIMENTAZIONE CENTRALE
106170GM alimentazione centrale
106290GM alimentazione centrale 2

Consente di alimentare la linea da un punto luce a soffitto. Disponibile anche per doppia accensione.

Component to supply power to the line from one ceiling point. Also available for double switch-on.

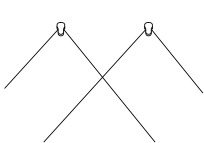
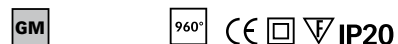

DEVIATORE
106180CR

Consente di deviare gli "Omnia cavo" con angolazioni differenti.

Component to detour "Omnia cavo" with different angles.

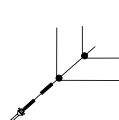

ANGOLARE A PARETE
107080CR

Supporto angolare parete. Angular wall support.

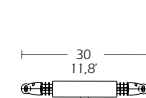

OMNIA CONNETTORE
527240GM 230V

527250GM 12V - 105W 

Consente di collegare alla linea Omnia lampade a sospensione. Montaggio per uscita verso alto o basso. Disponibile la versione per alimentazione a 230V ed alimentazione a 12V.

Useful for connecting hanging lamps or other devices to the Omnia line. Two versions available: 230V and 12V output. High or low output mounting direction.

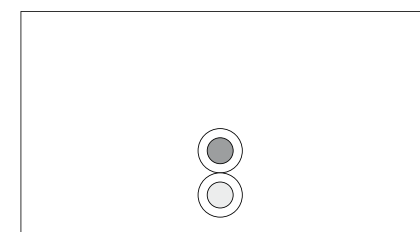
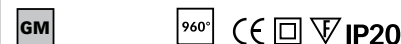

CAVO 2
106190XX Lunghezza a richiesta
Length by request

111930XX - L = 12 m/472,4'
111940XX - L = 20 m/787,4'
111950XX - L = 33 m/1300'
111960XX - L = 100 m/3937'

Cavo di alimentazione costampato con rinforzo in filo d'acciaio.

Power supply cable jointly-moulded cable, reinforced with steel wire.

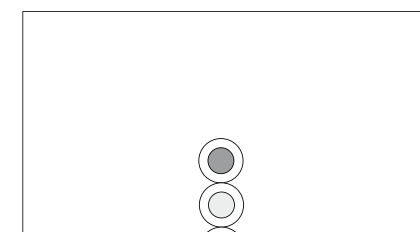

CAVO 3
106270XX Lunghezza a richiesta
Length by request

111970XX - L = 12 m/472,4'
111980XX - L = 20 m/787,4'
111990XX - L = 33 m/1300'
112000XX - L = 100 m/3937'

Cavo di alimentazione, costampato con rinforzo in filo d'acciaio per ottenere accensioni alternate.

Power supply cable, jointly-moulded cable, reinforced with steel wire to obtain alternated lighting.



MONOECO

126



**MONOEGG 16
MONOEGG 20**

127



**MONOELLEUNO
MONOELLEDUE**

128



MONOTIGE E27

129



**MONOFLUO
28/35**

130



COMPONENTI DI LINEA

132

Corpo in policarbonato.
Diffusore in vetro satinato.

Frame in polycarbonate.
Satined glass diffuser.

Corps en polycarbonate
Diffuseur en verre satiné.

Gehäuse aus polycarbonat.
Diffusor mit Sandgestahltem Glas.

Cuerpo en policarbonato.
Difusor en cristal satinado.



Corpo in policarbonato e tubo in ottone cromato. Disponibile con due vetri.





Frame in polycarbonate.
Chromium-plated brass tube.
Available with two sanded glasses.



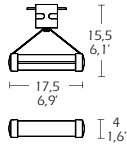
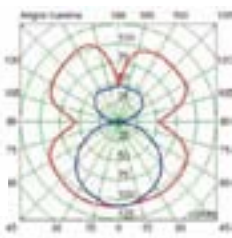

Corps en polycarbonate et tube de laiton chromé. Disponible dans les versions avec deux verres dépolis.



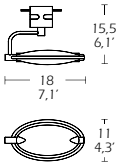
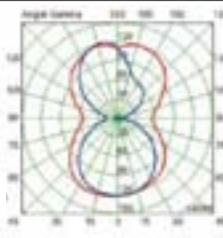

Gehäuse aus polycarbonat und Rahmen aus verchromtem Messing. Erhältlich mit zwei sandgestahlten Glasscheiben.

Cuerpo en policarbonato y tubo en latón cromado. Disponible con dos cristales.

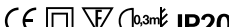

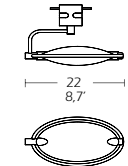
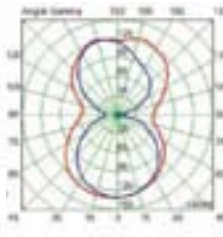
			110940.. 1 x 230W	
			MONOECO	KG/LBS
CODE	DESCRIPTION	NOTES		
110940GM	1 x 250W	 112380ES ALO HDG 230W 230V R7s-114.2 ES	0,45/1	
				

			110620.. 1 x 100W	
			MONOEGG 16	KG/LBS
CODE	DESCRIPTION	NOTES		
110620GM	1 x 100W	 108080XX ALO HDG 100W 230V R7s-74.9 QT-DE12 108080ES ALO HDG 80W 230V R7s-74.9 ES	0,45/1	
				

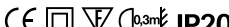
			110630.. 1 x 200W	
			MONOEGG 20	KG/LBS
CODE	DESCRIPTION	NOTES		
110630GM	1 x 200W	 108270XX ALO HDG 200W 230V R7s-114.2 QT-DE 108270ES ALO HDG 160W 230V R7s-114.2 ES	0,54/1,2	
				

Corpo in policarbonato e tubo in ottone cromato. Diffusore in vetro satinato.

Frame in polycarbonate.
Chromium-plated brass tube.
Satinated glass diffuser.

Corps en polycarbonate et tube de laiton chromé.
Diffuseur en verre satiné.

Gehäuse aus polycarbonat und Rahmen aus verchromtem Messing.
Diffusor mit Sandgestahltem Glas.

Cuerpo en policarbonato y tubo en latón cromado.
Difusor en cristal satinado.



Faretto con Tige per lampade E27.
Spot with steam for E27 bulb.
Spot avec tige pour ampoules E27.
Strahler mit Ständer für Halogenleuchte E27.
Spot con tija para lámpara E27.

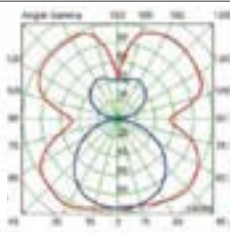
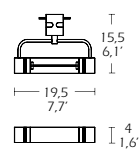

110600... 1 x 120W

MONOELLEUNO	CODE	DESCRIPTION	NOTES	KG/LBS
	110600GM	1 x 150W	108210XX ALO HDG 150W 230V R7s-74.9 QT-DE 108210ES ALO HDG 120W 230V R7s-74.9 ES	0,5/1,1

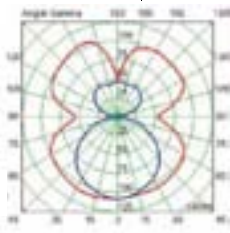
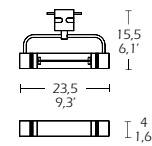

110610... 1 x 230W

MONOELLEDUE	CODE	DESCRIPTION	NOTES	KG/LBS
	110610GM	1 x 250W	112380ES ALO HDG 230W 230V R7s-114.2 ES	0,7/1,54

GM ES CE IP20

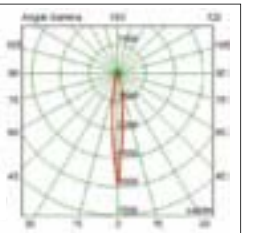
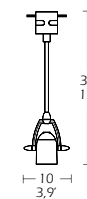

110770... 1 x 100W

MONOTIGE E27	CODE	DESCRIPTION	NOTES	KG/LBS
	110770GM	1 x 100W	111710XX ALO HAGS 50W 230V E27 PAR20	0,2/0,4

GM 355° 270° CE IP20



Corpo in policarbonato ed in estruso di alluminio per lampade fluorescenti ad alta efficienza alimentate elettronicamente.



Frame in polycarbonate and extruded aluminium for fluorescent bulbs. Feature electronic supply control.

Corps en polycarbonate et en aluminium extrudé pour ampoules fluorescents. Alimentation électronique.

Gehäuse aus polycarbonat und Aluminium für Leuchtstofflampen mit elektronische Versorgung.

Cuerpo en policarbonato y "in estruso" de aluminio para fluorescente de alta eficacia alimentados electronicamente.



MONOFLUO 28/35	CODE	DESCRIPTION	NOTES	KG/LBS
	111000GM	L = 129/50,8' 1 x 28W	 110980XX FL FH 28W 230V G5 T16	1,23/2,7
	110800GM	L = 159/62,5' 1 x 35W	 110950XX FL FH 35W 230V G5 T16	1,45/3,2

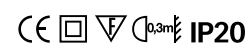

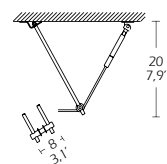

MONO DISTANZIATORE 20
110890CR - H = 20/7,9'

Consente di fissare il tendicavo a soffitto in assenza di pareti. Tendicavo non incluso.

Ceiling fixing component for Monocavo. Cable tensioner not included.

CR

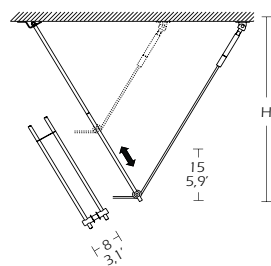

MONO DISTANZIATORE 40 REGOLABILE
111020CR - H = 25/9,8' ÷ 40/15,7'

Consente di fissare il tendicavo a soffitto in assenza di pareti. Tendicavo non incluso.

Ceiling fixing component for Monocavo. Cable tensioner not included.

CR

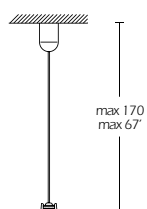

MONO SOSTEGNO
110900GM - H = max 170/67'

Consente di sostenere il cavo nel caso vi siano delle linee molto lunghe, oppure con numerosi corpi lampada.

Cable support for long lines, or with many lamps.

GM

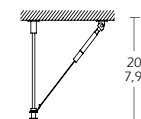

MONO ANGOLARE SOFFITTO 20
110910CR - H = 20/7,9'

Supporto angolare soffitto. Angular ceiling support.

CR

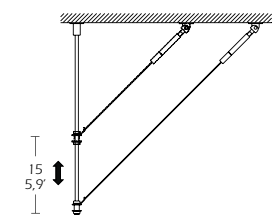

MONO ANGOLARE SOFFITTO 40 REGOLABILE
111030CR - H = 25/9,8' ÷ 40/15,7'

Supporto angolare soffitto. Angular ceiling support.

CR

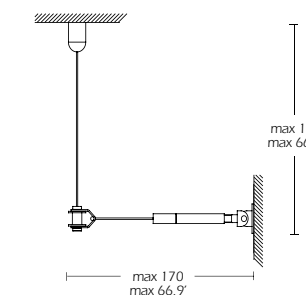

MONO ANGOLARE PARETE
110920CR - H = max 170/67'

Supporto angolare parete. Angular wall support.

CR

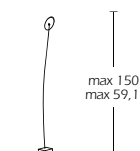

MONO ALIMENTATORE CENTRALE
110860GM - H = max 150/59,1'

Consente di alimentare la linea da un punto luce a soffitto.

Component to supply power to the line from one ceiling point.

GM

960°

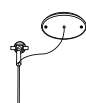
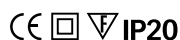

MONO TENDICAVO
110650CR

Gruppo tendicavo per alimentare e tendere la linea elettrica.

Cable tensioner unit to supply and stretch the electrical line.

CR

960°

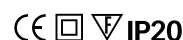

MONO CAVO
110590XX

Cavo di alimentazione. Lunghezza a richiesta.

Power supply cable. Length by request.

XX

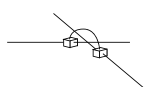

MONO CONNESSIONE
110870GM

Permette di collegare più linee elettriche con un solo punto di alimentazione.

Component to connect more electric lines with only one power supply point.

GM

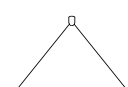

MONO DEVIATORE
110880CR

Consente di deviare i "Monocavo" con angolazioni differenti.

Component to detour "Monocavo" with different angles.

CR

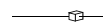

MONO SEPARATORE
110930GM

Permette di separare le linee elettriche per ottenere una doppia accensione.

Separator component to obtain double lighting.

GM

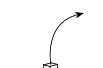

MONO DERIVAZIONE
111180GM

Permette di collegare alla linea apparecchi supplementari.

Enables supplementary devices to be connected to the mains

GM



D CAVO ALO

136

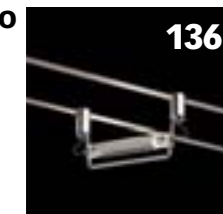

D CAVO SPOT

138

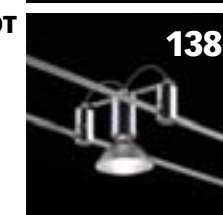

D CAVO FLUO

139

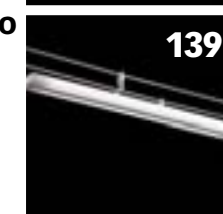

COMPONENTI DI LINEA

140

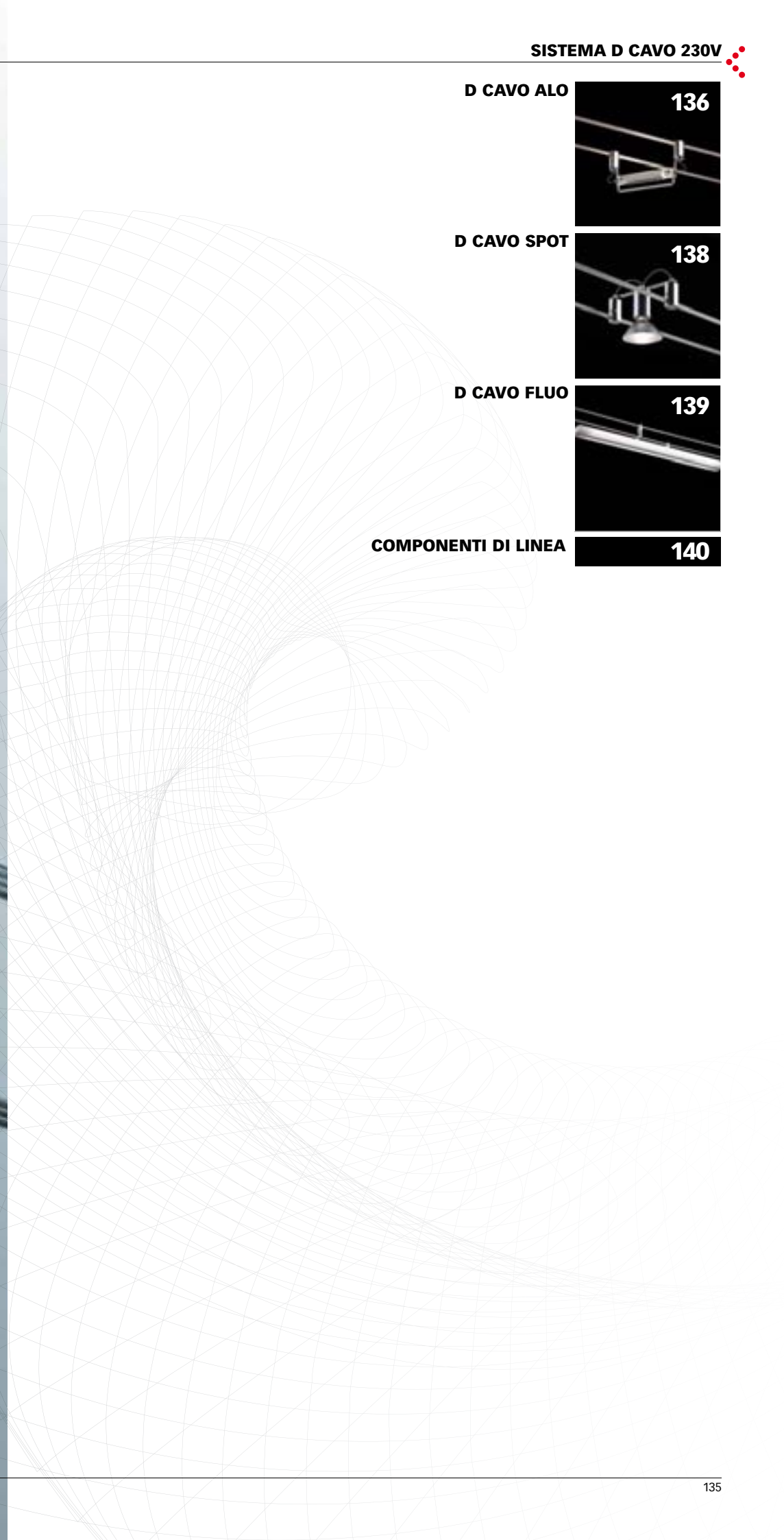



Sistema su cavo a tensione di rete che offre numerose possibilità di utilizzo. La caratteristica principale ed innovativa è quella di permettere configurazioni su cavo singolo, doppio e misto, ovvero singolo/doppio (fino a tre accensioni). Inoltre i corpi lampada possono essere installati sopra o sotto i cavi, ortogonalmente o parallelamente. Sono disponibili diverse sorgenti luminose ed accessori.

Mains-voltage system which offers many availment possibilities. The principal and innovative characteristic is to allow configurations on single/double cable, double and mixed cable, or else single/double (up to three switch-on). Furthermore the appliances can be installed upon and under the cables, at right angles or in parallel. Available different lighting sources and accessories.

Système sur câble à 230V qui offre plusieurs choix lumineux. La caractéristique principale est de permettre des configurations sur un unique câble, double câble ou unique/double câble (jusqu'à trois allumages). En plus les appareils peuvent être installés sous ou sur les câbles, orthogonalement ou parallèlement. Il offre plusieurs possibilités d'éclairage et d'accessoires.

Netzspannung Beleuchtungssystem mit verschiedene Nutzen Möglichkeiten. Gestaltungen mit einzeln Kabel, doppelt oder Gemischt, oder auch einzeln/doppelt (bis drei Anzündungen). Ist die hauptsächlich und beste Charakteristik. Außerdem man kann die Leuchtkörpern ober oder unter die Kabeln, senkrecht oder parallel einsetzen. Verschiedene Leuchtkörpern und Zubehör verfügbar.

Sistema de cable que ofrece múltiples posibilidades de utilización. La principal característica novedosa es que permite configurarse en un único cable, doble cable o único/doble cable (hasta tres encendidos). Además, los aparatos pueden ser instalados por encima o por debajo de los cables, ortogonalmente o paralelamente. Ofrece diversas posibilidades de fuentes luminosas y accesorios.

SISTEMA D CAVO - 18/7,1'
interasse/width/entraxe/distanz/distancia entre ejes









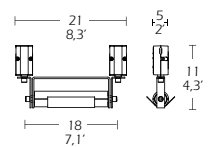

Configurazioni - Configurations - Configurations - Gestaltungen - Configuraciones

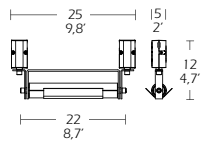

Cavo singolo - Single cable - Cable unique - Einzeln Kabel - Cable unico

Cavo doppio (passo 18/7,1') - Cable double (Entraxe 18/7,1')
Double cable (width 18/7,1') - Doppelt Kabel (Distanz 18/7,1') - Cable doble (distancia 18/7,1')

Cavo doppio (passo ridotto) - Double cable (reduced)
Cable double (Entraxe reduite) - Doppelt Kabel (Distanz Verkleinert) - Cable doble (reducido)

Cavo singolo-doppio - Single-double cable - Unique-double cable
Einzeln-Doppelt Kabel - Cable unico/doble

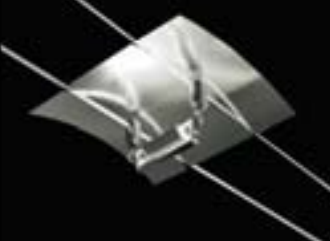
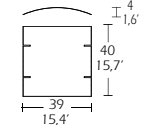
				
D CAVO ALO 1	CODE 522240CR	DESCRIPTION 1 x 150W	NOTES  108210XX ALO HDG 150W 230V R7s-74.9 QT-DE 108210ES ALO HDG 120W 230V R7s-74.9 ES	KG/LBS 0,38/0,8
				
D CAVO ALO 2	CODE 522250CR	DESCRIPTION 1 x 250W	NOTES  112380ES ALO HDG 230W 230V R7s-114.2 ES	KG/LBS 0,42/0,9
	  	  		

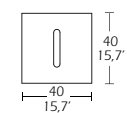
				
D CAVO RIFLETTORE	CODE 522490XX	DESCRIPTION riflettore alluminio/aluminium reflector	NOTES	KG/LBS 0,25/0,57
				
D CAVO DIFFUSORE	CODE 522500XX	DESCRIPTION diffusore policarbonato/diffuseur in polycarbonate	NOTES	KG/LBS 0,25/0,57

D CAVO SPOT

design **Mario Barbaglia** 2007

Spot con attacco E27 per sistema D Cavo.
Corpo in acciaio cromato.
Due versioni: fissa e orientabile.
Installabili indifferentemente verso l'alto o verso il basso.

Spot with E27 attachment for D Cavo system. Chromed steel body.
Two versions: fixed and adjustable.
Can be installed to direct light upwards or downwards without distinction.

Spot avec douille E27 pour système D Cavo.
Corps en acier chromé. Deux versions: fixe et orientable. Installables indifféremment vers le haut ou vers le bas.

Spot mit E27-Fassung für das System D Cavo. Gehäuse aus verchromtem Stahl.
Zwei Ausführungen: fest und drehbar.
Können sowohl nach oben als auch nach unten gerichtet installiert werden.

Foco con casquillo E27 para sistema D Cavo.
Cuerpo de acero cromado.
Dos versiones: fija y orientable.
Se pueden instalar, indistintamente, hacia arriba o hacia abajo.

SISTEMA D CAVO - 18/7,1'

interasse/width/entraxe/distanz/distancia entre ejes

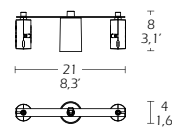

D CAVO SPOT 1	CODE	DESCRIPTION	NOTES	KG/LBS
	522260CR	1 x 75W	 111670XX ALO HAGS 75W 230V E27 PAR30 111710XX ALO HAGS 50W 230V E27 PAR20	0,3/0,7

D CAVO SPOT 2	CODE	DESCRIPTION	NOTES	KG/LBS
	522270CR	1 x 75W	 111670XX ALO HAGS 75W 230V E27 PAR30 111710XX ALO HAGS 50W 230V E27 PAR20	0,33/0,7

CR

ES 850°

CE    IP20

D CAVO FLUO

design **Mario Barbaglia** 2007

Lampada fluorescente per il sistema D Cavo.
Struttura in acciaio verniciato grigio metallizzato.
Diffusori in policarbonato opalino bianco.
Alimentatore elettronico multi potenza.
Potenze da 39 a 54W in versione standard oppure DALI. Versione con emergenza disponibile su richiesta. Grazie al sistema di montaggio con supporti orientabili, l'elemento può essere montato sia in versione monocavo sia con cavi paralleli per un interasse fino a 36 cm (14").

Fluorescent lamp for the D Cavo system.
Metallic grey coated steel structure. White opaline polycarbonate diffusers. Multi-power electronic ballast. Power from 39 to 54W in standard version or DALI. Version with emergency pack available on request. Mounting on adjustable brackets means the element can be installed on single cable and/or with parallel cables at a width of up to 36 cm (14").

Lampe fluorescente pour le système D Cavo. Structure en acier laqué gris métallisé.
Diffuseurs en polycarbonate opalin blanc. Ballast électronique multi-puissance. Puissances de 39 à 54W en version standard ou DALI. Version avec éclairage d'urgence disponible sur demande. Grâce au système de montage avec supports orientables, l'élément peut être monté tant en version monocâble qu'avec des câbles parallèles pour un entraxe maximal de 36 cm (14").



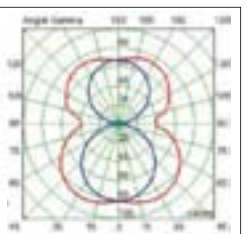
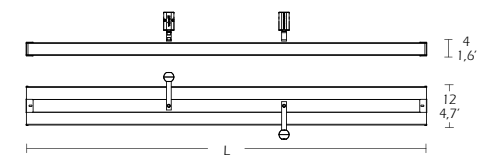

Leuchtstofflampe für das System D Cavo. Struktur aus grau metallic lackiertem Stahl. Diffusor aus opalweißem Polykarbonat. Elektronisches Multipower-Vorschaltgerät. Leistungen von 39 bis 54W in der Standard- oder DALI-Ausführung. Version mit Notfunktion auf Anfrage. Durch das Montagesystem mit drehbaren Halterungen kann das Element sowohl als Einkabelauführung als auch mit parallel verlaufenden Kabeln mit einem Abstand bis 36 cm (14") montiert werden.

Lámpara fluorescente para el sistema D Cavo. Estructura de acero pintado gris metalizado. Difusores de policarbonato opalino blanco. Balasto electrónico de multi-potencia. Potencias de 39 a 54W en versión estándar o bien DALI. Versión con emergencia disponible bajo pedido. Gracias al sistema de montaje con soportes orientables, el elemento se puede montar tanto en versión de un solo cable como con cables paralelos para una distancia entre ejes de hasta 36 cm (14").

SISTEMA D CAVO - 18/7,1'
interasse/width/entraxe/distanz/distancia entre ejes



522280.. 2 x 54W
522800.. 2 x 54W

D CAVO FLUO	CODE	DESCRIPTION	NOTES	KG/LBS
	522650GM	L = 90/35,4' 2 x 39W	 109070XX FL FQ 39W 230V G5 T16 110390XX FL FH 21W 230V G5 T16	2,3/5,1
	522810GM	L = 90/35,4' 2 x 39W		
	522280GM	L = 120/47,2' 2 x 54W	 109080XX FL FQ 54W 230V G5 T16 110980XX FL FH 28W 230V G5 T16	2,5/5,5
	522800GM	L = 120/47,2' 2 x 54W		

GM

ES EL 850° MP

CE   IP20

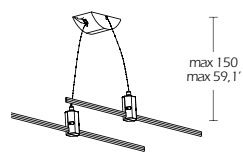

max 150
max 59,1'

D CAVO ALIM. CENTRALE
522550CR - H = max 150/59,1'

Consente di alimentare la linea da un punto luce a soffitto. Disponibile anche per doppia accensione.

Component to supply power to the line from one ceiling point. Also available for double switch-on.

CR 960° CE IP20

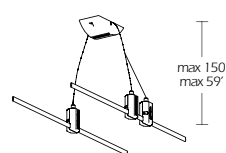

max 150
max 59,1'

D CAVO ALIM. CENTRALE 2
522560CR - H = max 150/59,1'

Consente di alimentare la linea da un punto luce a soffitto. Disponibile anche per doppia accensione. Alimentazione per linee doppie.

Component to supply power to the line from one ceiling point. Also available for double switch-on. Double line supply.

CR 960° CE IP20



D CAVO ALIMENTAZIONE
522340CR

Scatola di alimentazione
Power box

CR 960° CE IP20

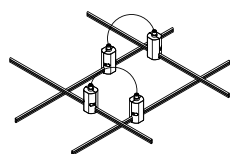

D CAVO CONNESSIONE
522570CR

Permette di collegare più linee elettriche con un solo punto di alimentazione.

Component to connect more electric lines with only one power supply point.

CR

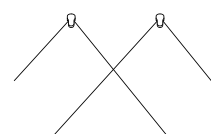

D CAVO DEVIATORE
106180CR

Consente di deviare i "D Cavo" con angolazioni differenti. Deviatore da parete o soffitto.

Component to detour "D Cavo" with different angles. Wall or ceiling diverter

CR

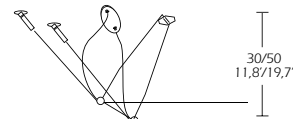

30/50
11,87/19,7

D CAVO DISTANZIATORE
522580CR

Consente di fissare i tendicavo "D" a soffitto in assenza di pareti. Escluso tendicavo.

Ceiling fixing component for "D" tendicavo. Cable stretcher not included.

CR

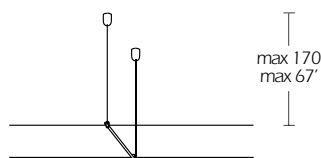

max 170
max 67'

D CAVO SOSTEGNO
522590CR - H = max 170/67'

Consente di sostenere i cavi nel caso vi siano delle linee superiori ai 8 mt., oppure quando vi siano numerosi corpi lampada.

Cable support for lines more than 8 mt. or with many lamps.

CR

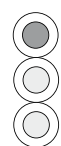

D CAVO
106270XX

Cavo di alimentazione costampato con rinforzo in filo d'acciaio a 3 fili, per ottenere accensioni alternate.

Power supply cable jointly-moulded reinforced with a steel wire, to obtain alternated lighting.

XX

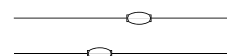

D CAVO SEPARATORE
106090GM

Permette di separare le linee elettriche per ottenere una doppia accensione.

Separator component to obtain double lighting.

GM

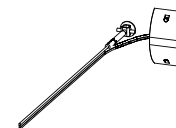

D CAVO TENDICAVO MONO
522600CR

Gruppo tendicavi per alimentare e tendere la linea elettrica. Set con 2 tasselli e due basette.

Cable tensioner unit with 2 blocks and 2 bases to supply and stretch one line.

CR 960° CE IP20

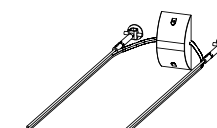

D CAVO TENDICAVO
522640CR

Gruppo tendicavi per alimentare due linee elettriche e tenderle. Set con 4 tasselli e due basette.

Cable tensioner unit. Cable stretcher set, with 4 blocks and 2 bases to supply and stretch two parallel lines.

CR 960° CE IP20

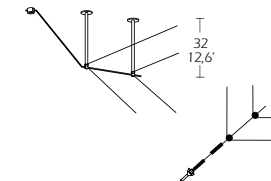

32
12,6'



D CAVO ANGOLARI
522620CR SOFFITTO
522630CR PARETE

Supporto angolare parete e soffitto. Angular wall and ceiling support.

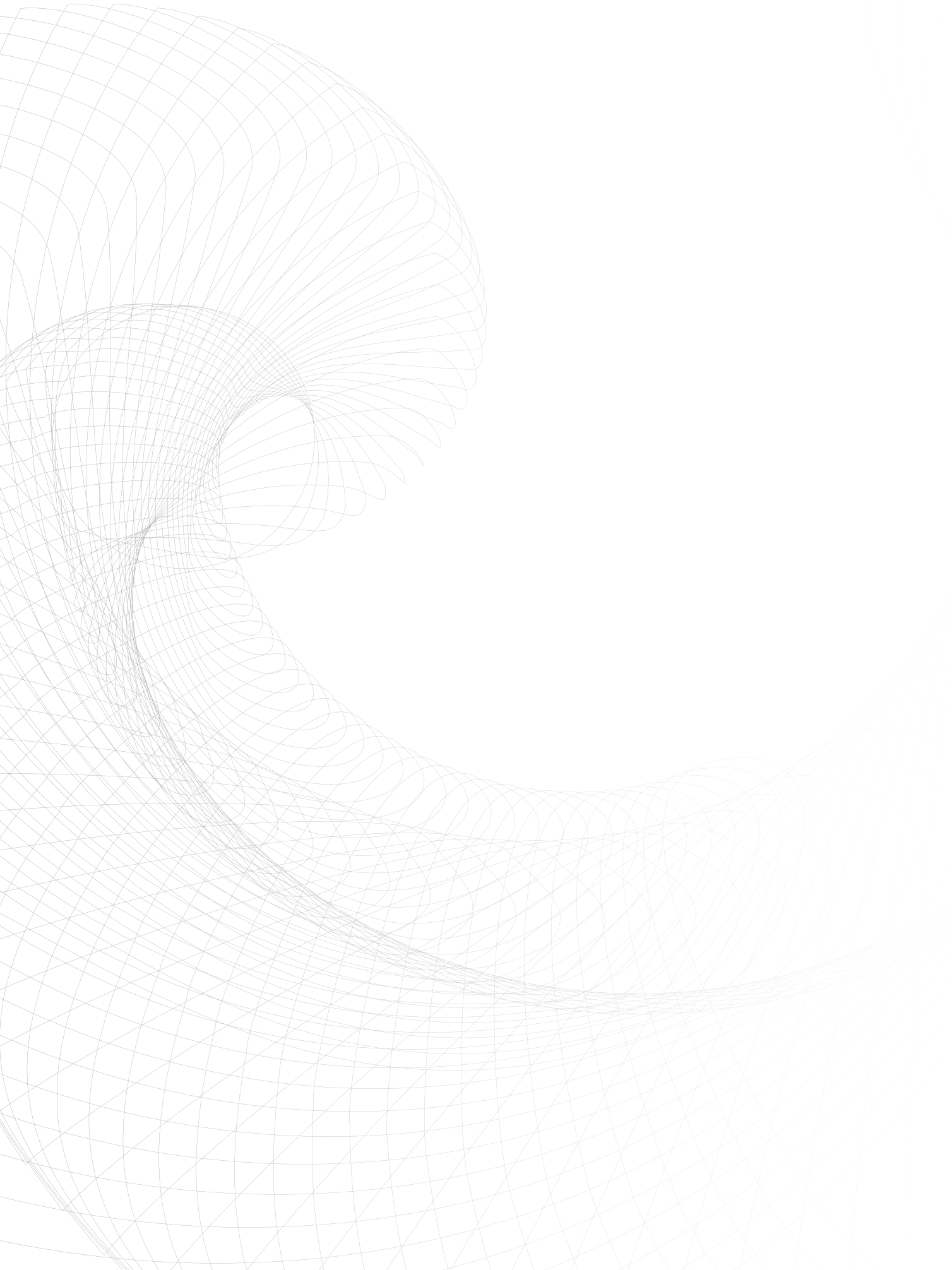
CR















TIPO INC	incandescente/incandescent	ILCOS	POTENZA	TENSIONE	ATTACCO	UNI	CODICE
	IAG	40W	230V	E27			110990XX
	IRA	100W	230V	E27			312020CR
	IRP	40W	230V	E14			312010CR 312010OR

TIPO A.M.	alogenuri metallici/metal halide						
	MD	70W	230V	Rx7s	HIT-DE		110440XX
	MRS	70W 35W	230V	E27	PAR30 PAR20		110970XX 112440XX
	MT	70W	230V	G 8.5			110960XX

TIPO FL	fluorescent/fluorescent						
	FBT	27W	230V	E27			112090XX
23W		108040XX					
20W		108320XX					
	FQ	80W	230V	G5	T16		109090XX
54W		109080XX					
39W		109070XX					
24W		109060XX					
8W		111700XX					
	FH	35W	230V	G5	T16		110950XX
28W		110980XX					
21W		110390XX					
	FSD	80W 36W	230V	2G11	TC-L		112170XX 108380XX
	FSQ	26W	230V	G24q-3	TC-DE		112300XX

TIPO FC	circolina fluorescente/fluorescent circoline						
	FC	55W	230V	2GX13	T16		111590XX
22W		111580XX					

TIPO ALO	alogeno/halogen						
	HDG	300W	230V	R7s-114.2	QT-DE		108790XX
230W		112380ES					
200W		108270XX					
160W		108270ES					
150W		108210XX					
120W		108210ES					
100W		108080XX					
80W		108080ES					
	HSGST	60W	230V	G9			110410ES
60W		110410XX					
40W		110400XX					
	HAGS	75W	230V	GU10	PAR20		111720XX
	HSGSA	105W	230V	E27			111760ES
70W		112390ES					
	HSGSP	42W	230V	E14			111740ES
42W		324710ES					
	HSG	28W	230V	E27	QT 32		111750ES
250W		108010XX					
150W		108280XX					
	HAGS	100W	230V	E27	PAR30		108290XX
100W		111870XX					
75W		108220XX					
	HSGST	50W	12V	GY6.35	QT12		111670XX
50W		108680XX					
35W		108680ES					
20W		108760XX					
	HSGST	20W	12V	G4	QT4		108700XX
14W		108700ES					
10W		108800XX					
	HMGS	75W	12V	G53			108800XX
	HRGS	35W	12V	GZ4			111820XX
35W		MR11					110370XX
20W		MR8 24°					109940XX
20W		MR8 21°					109930XX
	HRGS	50W	12V	GU5.3	QR-CB		112420XX
							108770XX

Progetto e direzione artistica:
Studio Mussi - Lissone (Mi)

Riprese fotografiche:
Tandem - Gaggiano (Mi)
Punto Zero - Mariano Comense (Co)

Stampa:
Tipolito Bellavite - Missaglia (Lc)

Printed in Italy 04/2010
© Valenti 2010

Tutti i diritti riservati. Nessuna parte del presente catalogo può essere riprodotta o diffusa con un mezzo qualsiasi, fotocopie, microfilm o altro, senza il permesso del titolare del copyright.
All rights reserved. No part of this catalogue may be reproduced or disclosed using any media whatsoever: photocopies, microfilms, etc., without the permission of the copyright owner.

L'azienda si riserva il diritto in qualunque momento di apportare senza preavviso modifiche a prodotti e accessori.
La tonalità dei colori è da considerarsi puramente indicativa.
The Manufacturer reserves the right to modify products and accessories at any time without prior notice.
The colour shade has to be considered just as an indication.

VALENTI s.r.l.

Via De Vecchi, 7d

20090 Assago (Mi) Italy

Tel. +39 02 45719175 +39 02 45719176 r.a.

Fax +39 02 45719177

www.valentiluce.it - valenti@valentiluce.it

www.prometeolight.it - prometeo@prometeolight.it

 **PROMETEO LIGHT**

divisione tecnica della **valenti** srl